



Sterisart® Family

Consumables for Sterility Testing

Product Information

The development and manufacturing of injectable, sterile medical products under GMP conditions is one of the most challenging and sensitive issues in the (bio-)pharmaceutical industry. Before a batch of the parenterals concerned can be released by the quality control department (QC), proof of sterility must be provided by performing the sterility test according to USP <71> and Eu. Phr. 2.6.1.



International Guidelines and Requirements

According to international pharmacopeias, parenterals injected into the human or animal body are subject to sterility testing. However, other products must be tested for sterility as well, for example:

- Injectables (vaccines, antibiotics, diabetes medications)
- Ophthalmics
- Immunodiagnostics (urine | blood, etc.)
- Intermediates | APIs
- Cell culture media
- Cell banks
- Virus banks
- Medical instruments (e.g., scalpels)
- Ointments
- Creams

Various analytical methods are used depending on the volume to be analyzed; e.g., membrane filtration or direct inoculation.

Generally, the sterility of each batch of a sterile drug is verified by performing the sterility test at the latest on such pharmaceuticals packaged in their final containers. Given the role of the test method in the federal laws of some countries (e.g., U.S. CFR 610.12), this qualitative test for the presence or absence of microorganisms, yeasts and fungi also has additional, legal significance.

Quality Control

As Sartorius is a recognized supplier of products and services for the pharmaceutical industry, product safety and quality are its number one priorities. To meet the quality requirements according to ISO 9001, representative samples of each lot of Sterisart® systems are subjected to destructive testing. In-process and final quality control tests further ensure high product safety. In addition to the bacteria challenge test and the Method Suitability test, the bubble point, flow rate, thickness and wetting time of the membrane are all checked.

Technical Specifications



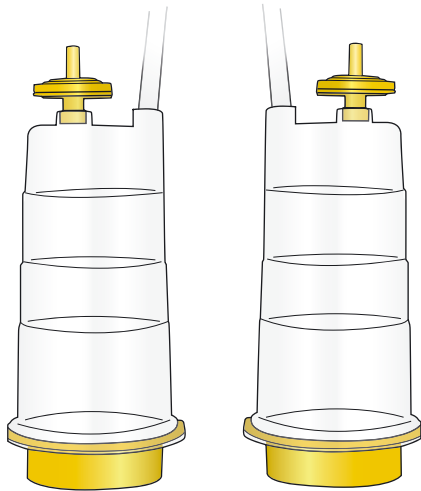

Basic Structure of Sterisart® RC Units with a Regenerated Cellulose Membrane

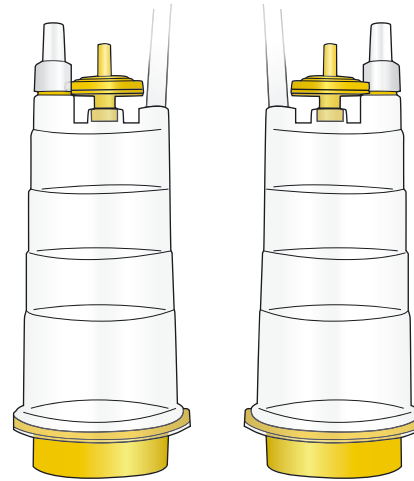

Standard configuration, order no. ending in GBD

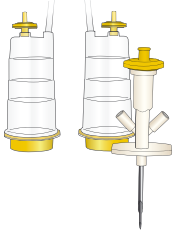
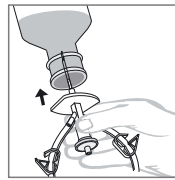

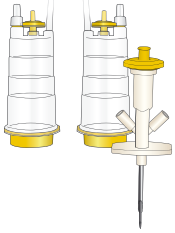
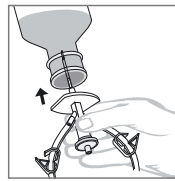
Configuration with septum, order no. ending in GSD

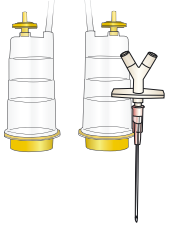
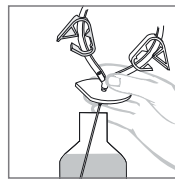









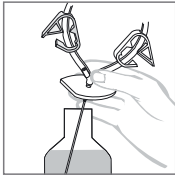

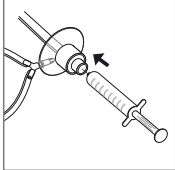
Sample Type	Product Container	Spike	Usage	Order Number
LVPs	Closed glass bottles with a septum 			16466-----GBD
LVPs	Closed glass bottles with a septum 		  septum	16466-----GSD
LVPs, SVPs	Open containers e.g. glass ampoules, glass bottles, collapsible plastic bags 			16467-----GBD

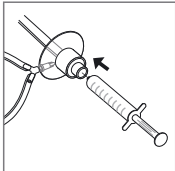
According to the United States Pharmacopeia:

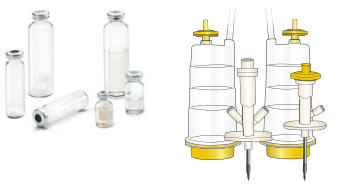
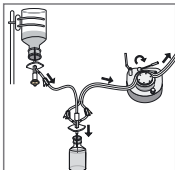
*LVPs: Large Volume Parenterals > 100 ml

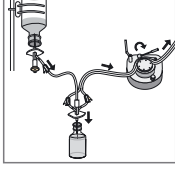
*SVPs: Small Volume Parenterals < 100 ml

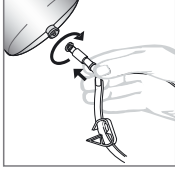
Basic Structure of Sterisart® RC Units with a Regenerated Cellulose Membrane

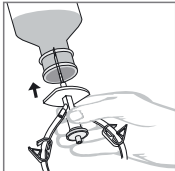



Sample Type	Product Container	Spike	Usage	Order Number
LVPs, SVPs	Open containers e.g. glass ampoules, glass bottles, collapsible plastic bags			 Septum 16467-----GSD
SVPs	Prefilled syringes with or without a spike			16469-----GBD
SVPs	Prefilled syringes with or without a spike			 Septum 16469-----GSD
Lyophilisates, soluble powders, liquid antibiotics	Closed glass bottles with a septum			16475-----GBD
Lyophilisates, soluble powders, liquid antibiotics	Closed glass bottles with a septum			 Septum 16475-----GSD
LVPs	One-connector system for testing tube assemblies and bags. Fits product containers with male Luer lock or female Luer slip connectors			16468-----GBD
SVPs	Closed glass bottles with a septum			16476-----GBD

According to the United States Pharmacopeia:

*LVPs: Large Volume Parenterals > 100 ml

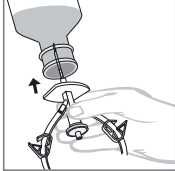
*SVPs: Small Volume Parenterals < 100 ml

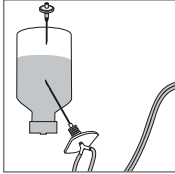
Basic Structure of Sterisart® RC Units with a Regenerated Cellulose Membrane

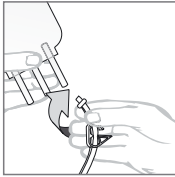
Sample Type	Product Container	Spike	Usage	Order Number
SVPs	Closed glass bottles with a septum		  Septum	16476-----GSD
LVPs, SVPs, eye drops	Closed containers; plastic containers with blow-fill seals; e.g. bottles, ampoules			16477-----GBD
LVPs	Two-connector system for testing product containers with a male Luer lock; double-needle spike for simultaneous transfer of rinsing liquid			16478-----GBD

According to the United States Pharmacopeia:

*LVPs: Large Volume Parenterals > 100 ml



*SVPs: Small Volume Parenterals < 100 ml

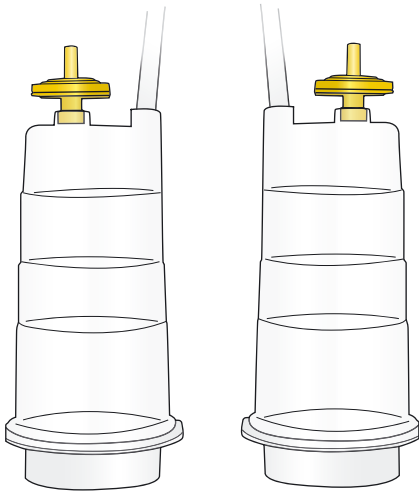

Basic Structure of Sterisart® CA Units with a Cellulose Acetate Membrane

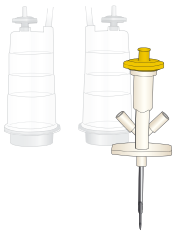
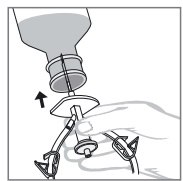

Standard configuration, order no. ending in GBD

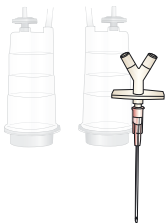
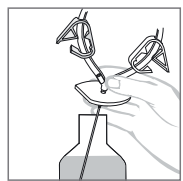



Sample Type	Product Container	Spike	Usage	Order Number
LVPs	Closed glass bottles with septum 			1646601-----GBD
LVPs, SVPs	Open containers; e.g., glass ampoules, glass bottles, collapsible plastic bags 			1646701-----GBD

According to the United States Pharmacopeia:

*LVPs: Large Volume Parenterals > 100 ml

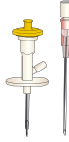
*SVPs: Small Volume Parenterals < 100 ml

Products for Direct Aseptic Transfer of Liquid Samples to Each Required Culture Medium

Sample Type	Product Container	Spike	Figure	Order Number
Liquids difficult to filter; medical materials	Closed glass bottles with a septum			16472-----GBD
Liquids difficult to filter; medical materials	Closed glass bottles with a septum open glass bottles			16471-----GBD

Sample Preparation

Sample Type	Product Container	Usage	Order Number
Powder with low solubility in closed glass bottles with a septum	Tube assembly with metal double needles of two different lengths 		16470-----GBD

Optional Accessories

Sample Type	Product Container	Usage	Order Number
Sterile venting of containers filled with rinsing solutions and culture media	Spike with 0.2 µm sterilizing-grade filter, 4 cm, stainless steel, individually sterile-packaged, gamma-sterilized 		16596-----HNK

Applications

Applications for Different Membranes and Systems

Sterisart® RC with a regenerated cellulose membrane is particularly suitable for testing aggressive, aqueous products and antibiotics.

Sterisart® CA with a cellulose acetate membrane has been specially designed to analyze the sterility of difficult-to-filter, viscous substances, such as emulsions, using membrane filtration.

Transfer sets: If the membrane filtration method cannot be used for sterility testing of liquid products, the Sartorius sterile transfer sets can be used for aseptic transfer of these products to liquid culture media for performing the direct inoculation method.

Overview of the Sterisart® Systems

Gamma-sterilized systems with regenerated cellulose (RC) membrane
16466-GBD, 16467-GBD, 16468-GBD, 16469-GBD, 16470-GBD, 16471-GBD, 16472-GBD, 16475-GBD, 16476-GBD, 16477-GBD, 16478-GBD,

Gamma-sterilized systems with a septum and a regenerated cellulose (RC) membrane
16466-GSD, 16467-GSD, 16469-GSD, 16475-GSD, 16476-GSD

Gamma-sterilized systems with a cellulose acetate (CA) membrane
1646601-GBD; 1646701-GBD

Note:

The primary packaging of the systems as well as the primary packing of the transfer kits are gas-tight. This enables them to be used directly in isolators and prevents unnecessary rinsing steps.

CONFIDENCE® Validation Services

Method Suitability Test (bacteriostasis | fungistasis) on request

EXPAND® Training

Available on request in your company or in our Training center.

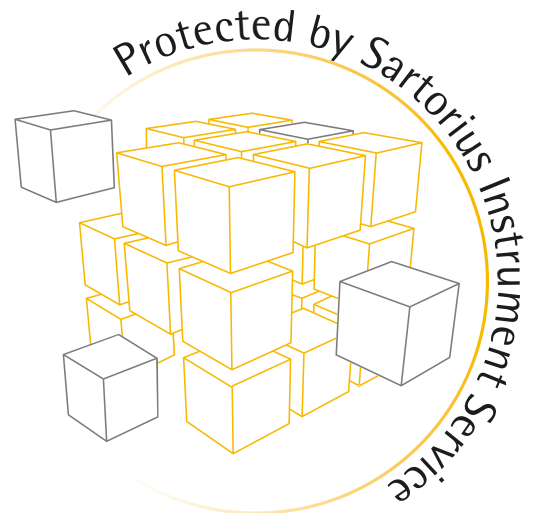

Sterisart® Universal Pumps for Transfer of Liquids to the Sterisart® Units

16420 with a display and a barcode scanner

16419 Basic version

Order number	Description
1ZG---0023	Drainage container cover for Sterisart® sterility test systems
1ZE---0033	Trolley for Sterisart Universal Pump
1ZGF---0020	Tray for 10 Sterisart® units
1ZE---0039	Trolley for pump
1ZA---0002	Drain tubing
1ZG---0028	Drainage container and cover for Sterisart® Sterility units
1ZGL---0033	Bottle holder without wing nut
1ZF---0007	Wing nut
1ZGD---0031	Stainless steel cover for the rotor
1EE---0010	External barcode scanner
1ZE---0050	Isolator installation kit
1ZG---0024	Drainage container cover for competitor's sterility test consumables
1ZG---0014	Adapter for Sterisart® systems in Equinox pumps; pkg. of 2
1ZA---0028	Drainage container for Sterisart® pump 16419 16420

Service

- EXTEND® instrument services for Sterisart® Universal pumps
- Installation qualification and operational qualification (IQ | OQ)
 - Preventive maintenance



General Technical System Details and Regulatory Requirements

The Sterisart® systems comply with GMP requirements with respect to sterility testing as well as to Regulation (EC) No. 1907/2006 (REACH) with particular reference to the plasticizer DEHP; ED/108/2014, ED/ 67/2008.

Sterilization

Gamma-sterilized at 25 kGy in compliance with DIN EN 552 and ISO 11137

Sterilization indicator on each carton; color change: from orange to red

Shelf Life



Gamma-sterilized units:
Sterile for up to 3 years after the date of manufacture;
guaranteed for a minimum of 6 months after delivery

Dimensions and Weight

Box (W × D × H) 28.1 × 27.3 × 24.6 cm



Weight of carton with 10 Sterisart® units Approx. 2.2 kg

Gas-tight individual packaging (W × D × H) 5.5 × 13 × 27 cm

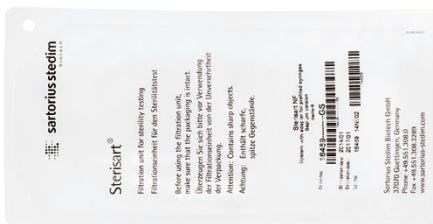

Weight of Sterisart® unit with packaging Approx. 185 g

From bottom to sterile air filter red cap attached (H × D) Approx. 13.8 × 5.7 cm

Weight of the Sterisart® unit without primary packaging Approx. 150 g, depending on the system version

Packaging

Primary packaging material	OPA PE sealing foil
Transparent film	A-PET/PE
Transport packaging material	Polyamide (PA) and polyethylene (PE)
Gas-permeable film	DuPontTMTyvek®
Transparent film	PETG (polyethylene terephthalate)

Sterisart® System

Method Suitability tests are performed on Sterisart® systems in compliance with the international pharmacopeias; USP <71> and Ph. Eur. 2.6.1.; an extractables profile has been created in compliance with the USP 23 and Ph. Eur. 3. The detection limits are below the requirements as specified for "water for injection".

Equal distribution of the product to the Sterisart® containers with a max. validated deviation of 10%

Regenerated cellulose (RC) membrane

Pore size	0.45 µm nominal; specified according to international pharmacopeias; USP <71>; Ph. Eur. 2.6.1
Effective filter area	15.7 cm ²
Integrity test	2.5 bar
Membrane thickness	Approx. 150 – 170 µm

Cellulose acetate (CA) membrane

Pore size	0.45 µm nominal; specified according to international pharmacopeias; USP <71>; Ph. Eur. 2.6.1
Effective filter area	14.5 cm ²
Integrity test	1.5 bar
Membrane thickness	115 – 145 µm

Hydrophobic (sterile venting) filters

Membrane	0.2 µm polytetrafluoroethylene (PTFE); validated according to HIMA for the retention of <i>Brevundimonas diminuta</i>
Burst pressure of the sterile air filter	At least 6 bar
Housing	Acrylic-based multipolymer
Water permeability pressure penetration pressure	> 3 bar

Sterisart® container

Upper part lower part	Styrene acrylonitrile (SAN)
Burst pressure of the housing	> 5 bar
Max. operating pressure	3 bar at 20°C
Max. operating temperature	50°C
Capacity	120 mL (50 mL, 75 mL and 100 mL graduated marks)
Red caps	Silicone
Integral membrane	Membrane incorporated in the system by a special clamping technology
Syringe holder	Styrene acrylonitrile (SAN) Sterisart® system, 16469



Female Luer lock and Luer slip connectors

Acrylonitrile butadiene styrene (ABS) Sterisart® system 16478

Accessory Materials Kit

Wing nuts	Polyethylene (PE)
-----------	-------------------

Tubing and Spikes

Tubing material and length	PVC, 80 cm; Additionally in available as silicone tubing, order no. 16469; 60 cm
Sampling needle	Polycarbonate and stainless steel (Sterisart® system 16467)
Double-needle spike	Acrylonitrile butadiene styrene (ABS) and stainless steel
Needle for sterile venting	Polypropylene (PP) and stainless steel; PTFE membrane; Housing made of methyl acrylate-butadiene-styrene (MBS)

	Length	Outer Diameter
Needle for sterile venting of Sterisart® systems 16467,16477 and 16468	40 mm	1.6 mm
Needle for Sterisart® system 16467	52 mm	1.5 mm
Needle for Sterisart® system 16468	60 mm	1.5 mm
Double-needle spike (long) for Sterisart® system 16466	41 mm	2.8 mm
Double-needle spike (short) for Sterisart® system 16476	21 mm	2.8 mm
Double-needle spike for Sterisart® systems 16469, 16471, 16475, 16478	35 mm	2.8 mm
Double-needle spike for Sterisart® system 16475	23 mm	2.8 mm
Double-needle spike (short) for Sterisart® system (one connector) 16472	22 mm	2.8 mm
Double-needle spike (short) for Sterisart® system (one connector) 16470	23 mm	2.8 mm
Double-needle spike (long) for Sterisart® system (one connector) 16470	37 mm	2.8 mm

Septum Material (only in systems ending in GSD)

Protective cap	Polyethylene
Septum material	Polyisoprene and acrylonitrile butadiene styrene (ABS)

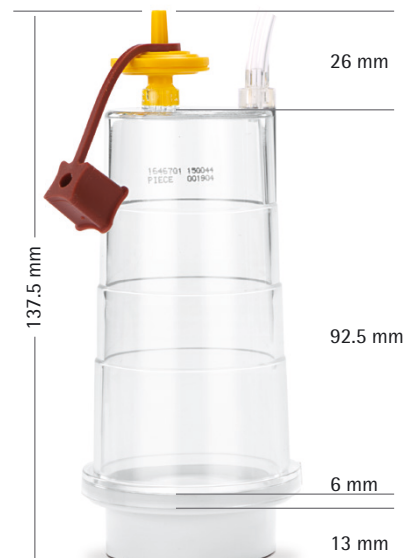
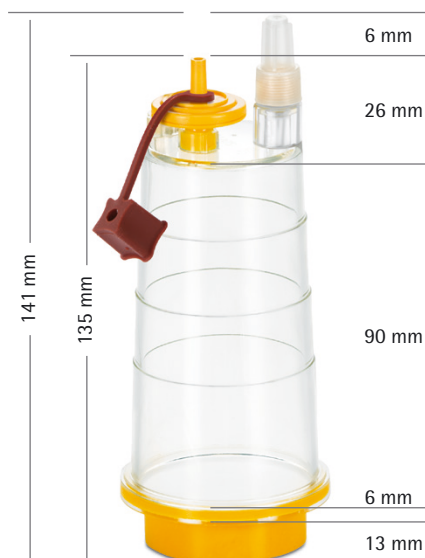

Sales and Service Contacts

For further contacts, visit www.sartorius.com

Europe

Germany

Sartorius Lab Instruments
GmbH & Co. KG
Otto-Brenner-Strasse 20
37079 Goettingen
Phone +49.551.308.0

France & Suisse Romande

Sartorius France
2, rue Antoine Laurent de Lavoisier
ZA de la Gaudrée
91410 Dourdan
Phone +33.1.70.62.50.00

Austria

Sartorius Austria GmbH
Modectcenterstrasse 22
1030 Vienna
Phone +43.1.7965760.0

Belgium

Sartorius Belgium N.V.
Rue Colonel Bourg 105
1030 Bruxelles
Phone +32.2.756.06.90

Finland & Baltics

Sartorius Biohit Liquid Handling Oy
Laippatie 1
00880 Helsinki
Phone +358.9.755.951

Hungary

Sartorius Hungária Kft.
Kagyló u. 5.
2092 Budakeszi
Phone +3623.457.227

Ireland

Sartorius Ireland Ltd.
Unit 41, The Business Centre
Stadium Business Park
Ballycoolin Road
Dublin 11
Phone +353.1.8089050

Italy

Sartorius Italy S.r.l.
Via Torino 3/5
20814 Varedo (MB)
Phone +39.0362.5557.11

Netherlands

Sartorius Netherlands B.V.
Phone +31.30.60.53.001
info.netherlands@sartorius.com

Poland

Sartorius Poland sp.z o.o.
ul. Wrzesinska 70
62-025 Kostrzyn
Phone +48.61.6473830

Russian Federation

LLC "Sartorius RUS"
Vasilyevsky Island
5th line 70, Lit. A
199178 St. Petersburg
Phone +7.812.327.53.27

Spain & Portugal

Sartorius Spain, S.A.
Avda. de la Industria, 32
Edificio PAYMA
28108 Alcobendas (Madrid)
Phone Spain +34.913.586.095
Phone Portugal +351.800.855.800

Switzerland

Sartorius Mechatronics Switzerland AG
Ringstrasse 24a
8317 Tagelswangen (ZH)
Phone +41.44.746.50.00

U.K.

Sartorius UK Ltd.
Longmead Business Centre
Blenheim Road, Epsom
Surrey KT19 9QQ
Phone +44.1372.737159

Ukraine

LLS "Sartorius RUS"
Post Box 440 "B"
01001 Kiev, Ukraine
Phone +380.44.411.4918

Americas

USA

Sartorius Corporation
565 Johnson Avenue
Bohemia, NY 11716
Phone +1.631.254.4249
Toll-free +1.800.635.2906

Argentina

Sartorius Argentina S.A.
Int. A. Ávalos 4251
B1605ECS Munro
Buenos Aires
Phone +1.631.254.4249
Toll-free +1.800.635.2906

Brazil

Sartorius do Brasil Ltda
Avenida Senador Vergueiro 2962
São Bernardo do Campo
CEP 09600-000 - SP- Brasil
Phone +55.11.4362.8900

Canada

Sartorius Canada Inc
1173 North Service Road West, D4
Oakville, ON L6M 2V9
Phone +1.905.569.7977
Toll-Free +1.800.668.4234

Mexico

Sartorius de México, S.A. de C.V.
Libramiento Norte de Tepetzotlan s/n,
Colonia Barrio Tlacateco,
Municipio de Tepetzotlan,
Estado de México,
C.P. 54605
Phone +52.55.5562.1102
leadsmex@sartorius.com

Asia | Pacific

Australia

Sartorius Australia Pty. Ltd.
Unit 5, 7-11 Rodeo Drive
Dandenong South Vic 3175
Phone +61.3.8762.1800

China

Sartorius (Shanghai) Trading Co., Ltd.
3rd Floor, North Wing, Tower 1
No. 4560 Jinke Road
Zhangjiang Hi-Tech Park
Pudong District
Shanghai 201210, P.R. China
Phone +86.21.6878.2300

Hong Kong

Sartorius Hong Kong Ltd.
Unit 1012, Lu Plaza
2 Wing Yip Street
Kwun Tong
Kowloon, Hong Kong
Phone +852.2774.2678

India

Sartorius Weighing India Pvt. Ltd.
#69/2-69/3, NH 48, Jakkasandra,
Nelamangala Tq
562 123 Bangalore, India
Phone +91.80.4350.5250

Japan

Sartorius Japan K.K.
4th Fl., Daiwa Shinagawa North Bldg.
8-11, Kita-Shinagawa 1-chome
Shinagawa-ku, Tokyo, 140-0001 Japan
Phone +81.3.6478.5200

Malaysia

Sartorius Malaysia Sdn. Bhd
Lot L3-E-3B, Enterprise 4
Technology Park Malaysia
Bukit Jalil
57000 Kuala Lumpur, Malaysia
Phone +60.3.8996.0622

Singapore

Sartorius Singapore Pte. Ltd
10 Science Park Rd
The Alpha #02-13/14
Singapore Science Park II
Singapore 117684
Phone +65.6872.3966

South Korea

Sartorius Korea Ltd.
8th Floor, Solid Space B/D,
PanGyoYeok-Ro 220, Bundang-Gu
SeongNam-Si, GyeongGi-Do, 463-400
Phone +82.31.622.5700

Thailand

Sartorius (Thailand) Co. Ltd.
129 Rama 9 Road,
Huaykwang
Bangkok 10310
Phone +66.2643.8361-6



◀ www.sartorius.com