



Lab Ultrafiltration and Purification Products

Simplifying Progress

SARTORIUS

Table of Contents

General Information	
Major Uses for Ultrafiltration	4
Sartorius Lab Ultrafiltration Devices	5
Process Alternatives	5
Membrane Performance Characteristics	6
Membrane Selection Guide	7
Protein and Macromolecule Concentration	9
Centrifugal Filtration	
▪ Vivaspin® 500	10
▪ Vivaspin® 2	12
▪ Centrisart® I	15
▪ Vivaspin® Turbo 4	17
▪ Vivaspin® 6	19
▪ Vivaspin® 15R	22
▪ Vivaspin® Turbo 15 PES	24
▪ Vivaspin® Turbo 15 RC	26
▪ Vivaspin® 20	28
▪ Vivaclear	32
Pressure-Fugation	
▪ Vivacell 100	33
Tangential Flow Filtration	
▪ Vivaflow® 50	36
▪ Vivaflow® 50R	39
▪ Vivaflow® 200	41
Solvent Adsorption	
▪ Vivapore® 5, 10 20	44
Ultrafiltration Membrane Filters from PES 146..., CTA 145... and RC 144...	46

DNA Concentration	49
Vivacon® 500	50
Vivacon® 2	53
Protein Purification	57
Vivapure® Ion Exchange Protein Purification Products	58
Virus Purification and Concentration	61
Vivapure® Virus Purification and Concentration Kits	62
Adenovirus Purification with Vivapure® AdenoPACK Kits	63
▪ Vivapure® AdenoPACK 20	64
▪ Vivapure® AdenoPACK 100	65
▪ Vivapure® AdenoPACK 500	67
Lentivirus Purification with Vivapure® LentiSELECT Kit	68
▪ Vivapure® LentiSELECT 40	69
▪ Vivapure® LentiSELECT 500	70
▪ Vivapure® LentiSELECT 1000	71
Application Notes	73
1. Desalting and Buffer Exchange with Vivaspin® Centrifugal Concentrators	74
2. Treatment of Vivaspin® Concentrators for Improved Recovery of Low-concentrated Protein Samples	77
3. Scouting Protein Purification Conditions Using Vivapure® Centrifugal Ion Exchange Membrane Absorbers	80
4. Sartorius Ultrafiltration Products for the Concentration and Purification of Viruses – a Short Review	85
5. Sartorius Ultrafiltration Products in the Preparation of Biological Nanoparticles and Medical Nanocarriers	91

Major Uses for Ultrafiltration

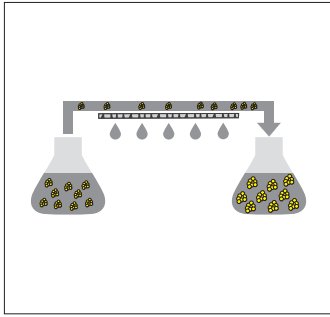

Solute concentration

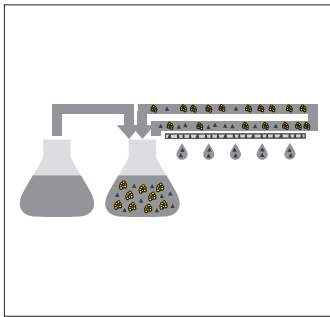

Solute fractionation or clarification

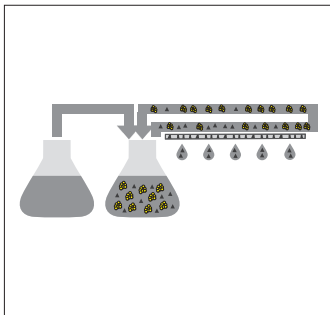

Solute desalting or purification

Ultrafiltration is a convective process that uses anisotropic semi-permeable membranes to separate macromolecular species and solvents primarily on the basis of size. It is particularly appropriate for the concentration of macromolecules and can also be used to purify molecular species or for solvent exchange. Ultrafiltration is a gentle, non denaturing method that is more efficient and flexible than alternative processes

Typical applications for ultrafiltration

- Concentration | desalting of proteins, enzymes, DNA, monoclonal antibodies, immunoglobulins, extracellular vesicles, viruses, virus like particles
- Free drug, hormone assays
- Removal of primers from PCR amplified DNA
- Removal of labelled amino acids and nucleotides
- HPLC sample preparation
- Deproteinization of samples
- Recovery of biomolecules from cell culture supernatants, lysates
- General purpose laboratory concentration and desalting of proteins, enzymes, cells, DNA, biomolecules, antibodies and immunoglobulins
- Mammalian cell harvesting
- Cell washing, virus purification, cell debris removal, depyrogenation
- Environmental sample clarification | concentration

Solute concentration

Ultrafiltration membranes are used to increase the solute concentration of a desired biological or inorganic species. The filtrate is cleared of macromolecules which are significantly larger than the retentive membrane pores. Microsolute is removed convectively with the solvent.

Solute fractionation or clarification

Ultrafiltration is a cost effective method for separating samples into size-graded components providing that macromolecular fractions differ in size by a 10× MW difference. During filtration, the permeating solute remains at its initial concentration whilst the retained macromolecules will be enriched.

Solute desalting or purification

A solution may be purified from salts, non-aqueous solvents and generally from low molecular weight materials. Multiple solvent exchanges, will progressively purify macromolecules from contaminating solutes. Microsolutes are removed most efficiently by adding solvent to the solution being ultrafiltered at a rate equal to the speed of filtration. This is called diafiltration.

Sartorius Lab Ultrafiltration Devices

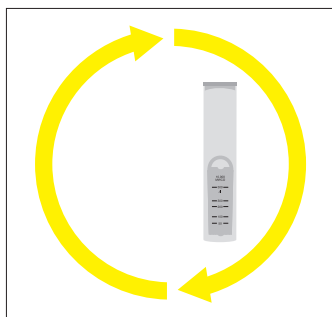

Centrifugal concentrators

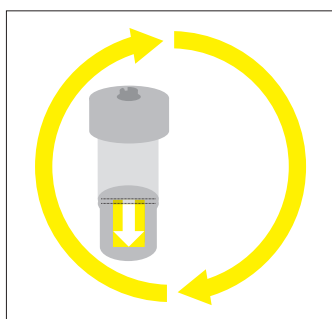

Pressure-fugation

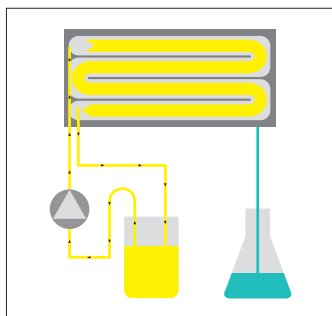

Cross flow

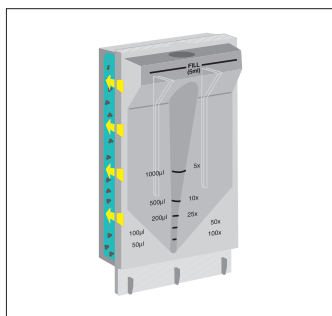

Solvent absorption

Sartorius develops devices dedicated for optimising laboratory ultrafiltration processes for the purpose of minimising processing times and maximising recovery, reliability and robustness.

In addition Sartorius are continually building technical and application

support tools to help users select the optimum device and process for their sample type.

Visit www.sartorius.com for more technical and application support material.

Process Alternatives

Sartorius offers a comprehensive range of process alternatives for the filtration and concentration of biological samples. Below is a guide to selecting the most suitable filtration method, depending on sample volume, equipment available, filtration speed and process control desired.

Centrifugal concentrators (100 µL to 100 mL starting volumes)

Centrifugation provides the vector to clear solvent and micro molecules through the ultrafiltration membrane and into a filtrate container positioned below. This is a gentle process that is characterised by quick set up and fast filtration speeds with most solutions. Sartorius offers thirteen alternative centrifugal devices covering volumes from 100 µL up to 100 mL.

Pressure ultrafiltration (5 to 100 mL starting volume)

Pressurised air or an inert gas is used to provide the filtration vector. For fastest filtration, Vivacell products are used with an orbital laboratory shaker. Agitation is used to impede macromolecules from polarising on the membrane surface and reducing filtration speed. Vivaspin® 20 and Vivacell 100 can be run with gas pressure.

Pressure-fugation is a unique Sartorius method that combines gas pressure with centrifugation. This is the fastest concentration method with process times typically 30 to 50% faster than centrifugation alone. Vivaspin® 20 can be operated this way (5 to 20 mL starting volumes).

Cross flow (100 mL to several litres starting volume)

The solution to be processed is pumped under pressure across an ultrafiltration membrane and then returned to the original reservoir. The solution is progressively concentrated or purified as solvent and micro-molecules pass through the membrane into a separate filtrate vessel. Vivaflow® 50, 50R and 200 are offered for this procedure.

Solvent absorption (1 to 20 mL starting volume)

This technique uses an absorbent cellulose pad mounted behind the ultrafiltration membrane to draw solvents and micro solutes through the membrane. Retained macromolecules are concentrated into the bottom of the sample container. No additional equipment is required. Two Vivapore® devices are offered for this procedure with maximum initial sample volumes ranging from 1 to 20 mL.

Membrane Performance Characteristics

Sartorius offers an extended range of membranes to cover the great majority of ultrafiltration requirements.

The following is a guide to selecting the most appropriate membranes according to their typical performance characteristics. Please note however, that membrane behavior and ultimate performance, largely depends on the specific characteristics of the solution being processed. Sartorius recommends that users experiment with alternative membranes in order to optimise their process performance.

Polyethersulfone (PES)

This is a low binding membrane that provides excellent performance with most solutions and exceptional recovery with negatively charged protein targets when retentate recovery is of primary importance. Polyethersulfone membranes are usually preferred for their low fouling characteristics, exceptional flux and broad pH range.

Regenerated Cellulose (RC)

This is a hydrophilic membrane suitable for general samples. With

ultra-low protein absorption and high chemical compatibility. The membrane is especially well suited to oligonucleotides and peptides. The Sartorius lab ultrafiltration Regenerated Cellulose membrane has been developed uniquely for ultrafiltration applications, ensuring optimal performance.

Cellulose triacetate (CTA)

High hydrophilicity and very low non specific binding characterise this membrane. Cast without any membrane support that could trap or bind passing micro solutes, these membranes are preferred for sample cleaning and protein removal and when high recovery of the filtrate solution is of primary importance.

Hydrosart®

Hydrosart® demonstrates the same properties as regenerated cellulose, but with the added benefit of enhanced performance characteristics and extremely low protein binding, making it another membrane of choice for applications such as concentration and desalting of immunoglobulin fractions.

Membrane performance comparisons

Membrane	Frequently preferred for:
Polyethersulfone & Regenerated Cellulose 3,000 MWCO 5,000 MWCO 10,000 MWCO 30,000 MWCO 50,000 MWCO 100,000 MWCO	Concentration Desalting Buffer exchange Fractionation
Deproteinization 5,000 MWCO 10,000 MWCO 20,000 MWCO	Free bound drug studies; Whenever the filtrate is being analysed
Hydrosart® 2,000 MWCO 5,000 MWCO 10,000 MWCO 30,000 MWCO	Concentration Desalting Buffer exchange Fractionation Hydrosart membrane evaluation for scale up

Membrane Selection Guide

The advanced designs and low adsorption materials that characterise Sartorius products, offer a unique combination of faster processing speeds and higher recovery of the concentrated sample. Providing that the appropriate device size and membrane cut-off is selected, Sartorius products will typically yield recoveries of the concentrated sample in excess of 90% when the starting sample contains over 0.1 mg/mL of the solute of interest. The majority of any loss is caused by non specific binding both to the membrane surface and to exposed binding sites on the plastic of the sample container:

Adsorption to the membrane

Depending on sample characteristics relative to the membrane type used, solute adsorption on the membrane surface is typically 2-10 µg/cm². This can increase to 20-100 µg/cm² when the filtrate is of interest and the solute must pass through the whole internal structure of the membrane. Typically a higher cut-off membrane will bind more than a low molecular weight alternative.

Adsorption to the sample container

Although every effort is made to minimise this phenomenon by the selection of low adsorption materials and tool

production to optical standards, some solute will bind to the internal surface of the sample container. Whilst the relative adsorption will be proportionately less important than on the membrane, due to the higher total surface area, this can be the major source of yield loss.

Process optimisation

When highest recoveries are most important, in particular when working with solute quantities in the micro-gram range, Sartorius recommends that users consider the following:

- Select the smallest device that suits the sample volume. Additionally, take advantage of the extra speed of Sartorius products by refilling a smaller device repeatedly.
- Select the lowest MWCO membrane that suits the application.
- Reduce pressure or centrifugal force to approximately half of the maximum recommended.
- Avoid over concentration. The smaller the final concentrate volume, the more difficult it is to achieve complete recovery. If feasible, after a first recovery, rinse the device with one or more drops of buffer and then recover again.
- Pretreat the device overnight with a passivation solution such as 5% SDS, Tween 20, or Triton X in distilled water. Then rinse thoroughly before use.

Membrane selection guide (recommended MWCO)

Application	< 5,000	10,000	30,000	50,000	100,000	> 300,000
Bacteria					•	•
DNA fragments		•	•	•	•	
Enzymes	•	•				
Extracellular Vesicle					•	•
Growth factors	•	•				
Immunoglobulins			•	•	•	
Nucleic Acids	•	•	•	•	•	
MAB			•	•	•	
Oligonucleotides	•					
Peptides	•					
Virus			•	•	•	
Yeast		•	•	•	•	•

For highest recovery, select a membrane MWCO which is at least half of the molecular weight of the solute to be retained



SARTORIUS

VIVAFLOW 50

SARTORIUS

VIVAFLOW 50

SARTORIUS

Protein and Macromolecule Concentration

Table of Contents

Vivaspin® 500	10
Vivaspin® 2	12
Centrisart® I	15
Vivaspin® Turbo 4	17
Vivaspin® 6	19
Vivaspin® 15R	22
Vivaspin® Turbo 15 PES	24
Vivaspin® Turbo 15 RC	26
Vivaspin® 20	28
Vivaclear	32
Vivacell 100	33
Vivaflow® 50	36
Vivaflow® 50R	39
Vivaflow® 200	41
Vivapore® 5, 10 20	44
Ultrafiltration Membrane Filters from PES 146..., CTA 145... and RC 144...	46

Vivaspin® 500

100 µL to 500 µL samples

Vivaspin® 500 µL centrifugal filter units offer a simple, one step procedure for sample preparation. They can effectively be used in a fixed angle rotors accepting 2.2 mL centrifuge tubes.

The legacy patented vertical membrane design and thin channel filtration chamber (US 5,647,990), minimises membrane fouling and provides high speed concentrations, even with particle laden solutions.

Technical specifications Vivaspin® 500

Concentrator capacity

Swing bucket rotor	do not use
Fixed angle rotor	500 µL

Dimensions

Total length	50 mm
Width	11 mm
Active membrane area	0.5 cm ²
Hold-up volume, membrane and support	< 5 µL
Dead stop volume	5 µL

Materials of construction

Body	Polycarbonate
Filtrate vessel	Polypropylene
Concentrator cap	Polycarbonate
Membrane	Polyethersulfone

Equipment required Vivaspin® 500

Centrifuge

Rotor type	Fixed angle
Minimum rotor angle	40°
Rotor cavity	To fit 2.2 mL (11 mm) conical bottom tubes
Maximum speed	15,000 g

Concentrate recovery

Pipette type	Fixed or variable volume
Recommended tip	Thin gel loader type

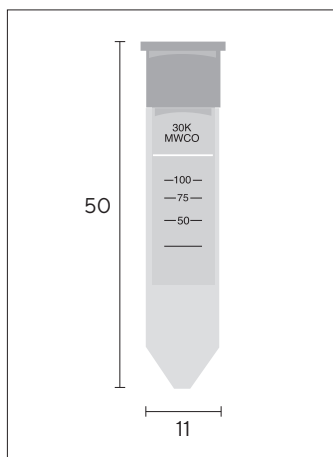

Performance characteristics

	Time to concentrate up to 30x [min.] at 20°C and solute recovery %	
Rotor	Fixed angle	
Centrifugal force	12,000 g	
Start volume	500 µL	
	Min.	Rec.
Aprotinin 0.25 mg/mL (6,500 MW) 3,000 MWCO PES	30	96%
BSA 1.0 mg/mL (66,000 MW) 5,000 MWCO PES	15	96%
10,000 MWCO PES	5	96%
30,000 MWCO PES	5	96%
IgG 0.25 mg/mL (160,000 MW) 30,000 MWCO PES	10	96%
50,000 MWCO PES	10	96%
100,000 MWCO PES	10	96%

Ordering information

Vivaspin® 500 Polyethersulfone	Pack size	Prod. no.
3,000 MWCO	25	VS0191
3,000 MWCO	100	VS0192
5,000 MWCO	25	VS0111
5,000 MWCO	100	VS0112
10,000 MWCO	25	VS0101
10,000 MWCO	100	VS0102
30,000 MWCO	25	VS0121
30,000 MWCO	100	VS0122
50,000 MWCO	25	VS0131
50,000 MWCO	100	VS0132
100,000 MWCO	25	VS0141
100,000 MWCO	100	VS0142
300,000 MWCO	25	VS0151
300,000 MWCO	100	VS0152
1,000,000 MWCO	25	VS0161
1,000,000 MWCO	100	VS0162
0.2 µm	25	VS0171
0.2 µm	100	VS0172
Starter pack (5 of each 5 k, 10 k, 30 k, 50 k, 100 k)	25	VS01S1

Vivaspin® 2

Choice of membranes

0.4–2 mL samples

The Vivaspin® 2 bridges the gap between the 500 µL and 4 mL centrifugal concentrators. This device combines the speed of the classic Vivaspin® products with low internal surface and membrane area for superior recoveries from very dilute solutions.

Also unique to the Vivaspin® 2, is the choice of directly pipetting the concentrate from the dead stop pocket built into the bottom of the concentrator, or alternatively reverse spinning into the concentrate recovery cap which can then be sealed for storage. Both methods result in near total concentrate recoveries.

Available with a choice of PES, Cellulose Triacetate and Hydrosart® membranes, Vivaspin® 2 offers the highest flexibility for process optimisation.

Technical specifications Vivaspin® 2

Concentrator capacity

Swing bucket rotor	3 mL
Fixed angle rotor	2 mL

Dimensions

Total length	126 mm
Width	17 mm
Active membrane area	1.2 cm ²
Hold-up volume of membrane	< 10 µL
Dead stop volume	8 µL

Materials of construction

Body	Polycarbonate
Filtrate vessel	Polycarbonate
Concentrator cap	Polycarbonate
Membrane	PES, CTA, HY

Equipment required Vivaspin® 2

Centrifuge

Rotor type	Swing bucket	Fixed angle
Minimum rotor angle	-	25°
Rotor cavity	To fit 15 mL (17 mm) conical bottom tubes	To fit 15 mL (17 mm) conical bottom tubes
Maximum speed	4,000 g	12,000 g*

Concentrate recovery

Pipette type	Fixed or variable volume	Fixed or variable volume
Recommended tip	Thin gel loader type	Thin gel loader type

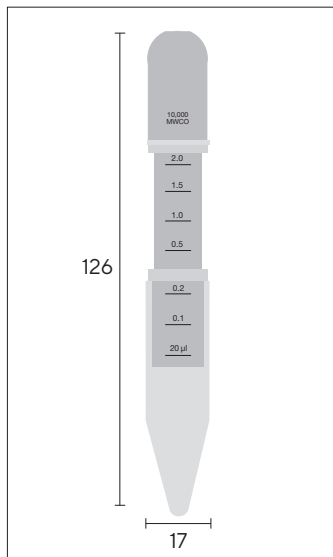

* Please note, devices with membrane MWCO >100 kDa need to be processed at lower g forces. See data sheets for details.

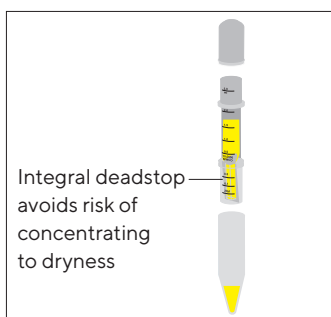

PES, CTA, or Hydrosart® membranes; Filtrate container fits standard 15 mL tube carriers

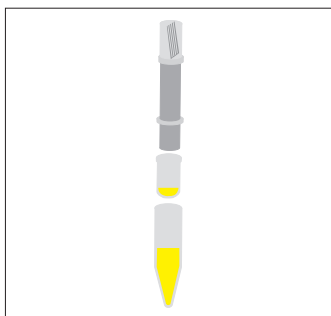

Direct pipette recovery or choice of reverse spinning concentrate into sample cap

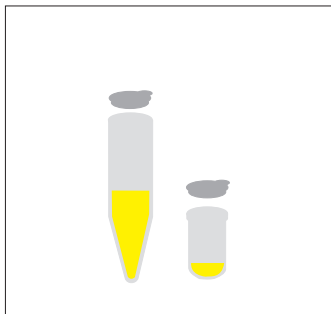

Filtrate and concentrate can be sealed for storage

Performance characteristics

	Time to concentrate up to 30x [min.] at 20°C and solute recovery %	
	Min.	Rec.
Rotor	Fixed angle	
Centrifugal force	5,000 g	
Start volume	2 mL	
Aprotinin 0.25 mg/mL (6,500 MW) 3,000 MWCO PES	50	96%
BSA 1.0 mg/mL (66,000 MW) 5,000 MWCO PES	12	98%
5,000 MWCO CTA	50	96%
5,000 MWCO Hydrosart®	22	98%
10,000 MWCO PES	8	98%
10,000 MWCO CTA	10	96%
10,000 MWCO Hydrosart®	12	98%
20,000 MWCO CTA	5	96%
30,000 MWCO PES	8	97%
30,000 MWCO Hydrosart®	5	97%
IgG 0.25 mg/mL (160,000 MW) 20,000 MWCO CTA	6	97%
30,000 MWCO PES	10	96%
50,000 MWCO PES	10	96%
100,000 MWCO PES	8	95%

Ordering tips

- Choose a membrane pore size at least 50% smaller than the size of the molecule to be retained.
- Usually choose Polyethersulfone membranes for fastest concentrations.
- Usually choose Cellulose Triacetate for Protein Removal | Ultrafiltrate recovery.
- Usually choose Hydrosart® membranes for highest recovery with Ig fractions.

Ordering information

Vivaspin® 2 Polyethersulfone	Pack size	Prod. no.
3,000 MWCO	25	VS0291
3,000 MWCO	100	VS0292
5,000 MWCO	25	VS0211
5,000 MWCO	100	VS0212
10,000 MWCO	25	VS0201
10,000 MWCO	100	VS0202
30,000 MWCO	25	VS0221
30,000 MWCO	100	VS0222
50,000 MWCO	25	VS0231
50,000 MWCO	100	VS0232
100,000 MWCO	25	VS0241
100,000 MWCO	100	VS0242
300,000 MWCO	25	VS0251
300,000 MWCO	100	VS0252
1,000,000 MWCO	25	VS0261
1,000,000 MWCO	100	VS0262
0.2 µm	25	VS0271
0.2 µm	100	VS0272
Starter pack (5 of each 5 k, 10 k, 30 k, 50 k, 100 k)	25	VS02S1
Vivaspin® 2 Cellulose triacetate	Pack size	Prod. no.
5,000 MWCO	25	VS02U1
5,000 MWCO	100	VS02U2
10,000 MWCO	25	VS02V1
10,000 MWCO	100	VS02V2
20,000 MWCO	25	VS02X1
20,000 MWCO	100	VS02X2
Vivaspin® 2 Hydrosart®	Pack size	Prod. no.
2,000 MWCO	25	VS02H91
2,000 MWCO	100	VS02H92
5,000 MWCO	25	VS02H11
5,000 MWCO	100	VS02H12
10,000 MWCO	25	VS02H01
10,000 MWCO	100	VS02H02
30,000 MWCO	25	VS02H21
30,000 MWCO	100	VS02H22

Centrisart® I

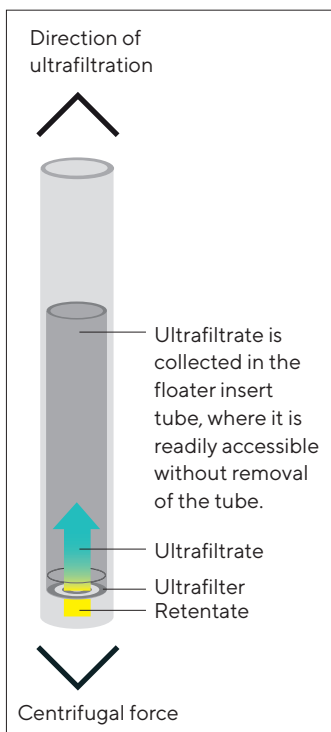

0.5–2.5 mL samples

Centrisart® I is a ready to use unit for small volume centrifugal ultrafiltration to separate proteins from low molecular weight substances in biological samples.

Centrisart® I features a unique design, ultrafiltration in the opposite direction to the centrifugal force. This is so effective in preventing premature blockage of the filter that even whole blood samples can be deproteinized.

The ultrafiltrate is collected in the floater insert tube, where it is readily accessible without removing the tube.

Typical applications include:

- drug binding studies
- determination of metabolites in serum
- protein removal from blood samples
- cleaning of liposomes
- virus removal

Technical specifications Centrisart® I

Concentrator capacity

Swing bucket rotor	2.5 mL
Fixed angle rotor	2.5 mL

Dimensions

Total length	93 mm
Width	14 mm
Active membrane area	0.79 cm ²
Hold-up volume of membrane	< 5 µL
Dead stop volume	100 µL

Materials of construction

Centrifuge tube	Polystyrene
Floater tube	Cellulose propionate
Cap	Polyethylene
Membrane	CTA, PES

Equipment required Centrisart® I

Centrifuge

Rotor type	Swing bucket	Fixed angle
Minimum rotor angle	-	25°
Rotor cavity	To fit 15 mL (17 mm) conical bottom tubes	To fit 15 mL (17 mm) conical bottom tubes
Maximum speed	2,500 g	2,000 g

Concentrate recovery

Pipette type	Fixed or variable volume	Fixed or variable volume
Recommended tip	Thin gel loader type	Thin gel loader type

Easy-to-use

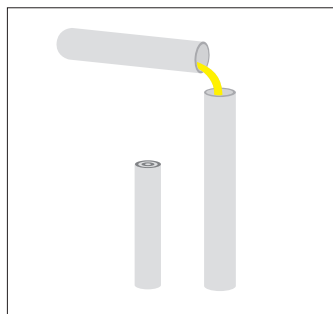

Remove interior tube, pour in sample

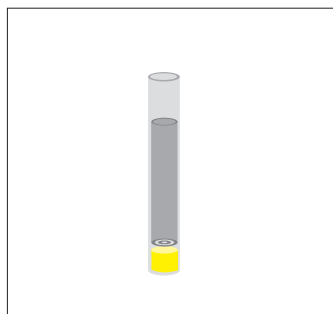

Replace interior tube

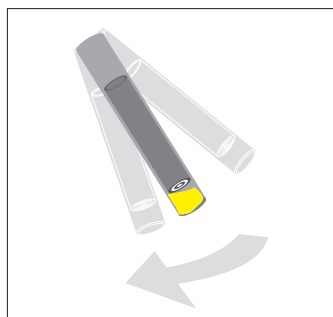

Centrifuge

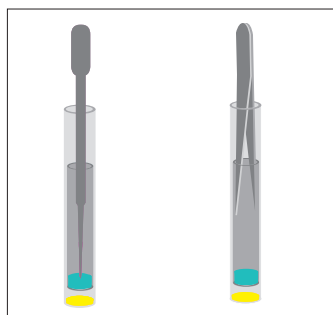

Pipette out the filtrate...

...or use forceps to remove the interior tube to access the concentrate

* 2.5 mL samples were loaded into each device. The devices were centrifuged at 2,000 g until the required filtrate volumes had been reached.

Performance characteristics

	Time to filter 50% of sample volume	Time to filter 90% of sample volume	Passage of sample species volume
BSA 1.0 mg/mL (66,000 MW) 5,000 MWCO	300 min	N/A	0%
10,000 MWCO	35 min	80 min	2%
20,000 MWCO	9 min	20 min	2%
IgG 0.25 mg/mL (160,000 MW) 100,000 MWCO	13 min	35 min	3%
Blue Dextran 0.1 mg/mL (2,000,000 MW) 300,000 MWCO	9 min	25 min	28%

Ordering information

	Pack size	Prod. no.
5,000 MWCO CTA	12	13229-E
10,000 MWCO CTA	12	13239-E
20,000 MWCO CTA	12	13249-E
100,000 MWCO PES	12	13269-E
300,000 MWCO PES	12	13279-E
Starter pack (3 units each of 5 k, 10 k, 20 k, 100 k)	12	13209-E

References

P. Nebinger and M. Koel
Determination of acyclovir by ultrafiltration and high-performance liquid chromatography.
J. Chromatography 619, 342-344 (1993)

R. H. Christenson, S. D. Studenberg, S. Beck-Davis and F. A. Sedor
Digoxin-like immunoreactivity eliminated from serum by centrifugal ultrafiltration before fluorescence polarization immunoassay of digoxin.
Clinical Chemistry 33, 606-608 (1987)

F. da Fonseca-Wollheim, K.-G. Heinze, K. Lomsky and H. Schreiner
Serum ultrafiltration for the elimination of endogenous interfering substances in creatinine determination.
J. Clin. Chem. Clin. Biochem. 26, 523-525 (1988)

Vivaspin® Turbo 4

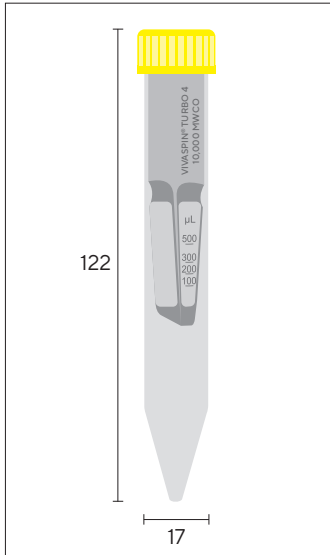

2–4 mL samples

Vivaspin® Turbo 4 is the newest member of the ultrafiltration family and allows the fastest sample concentration with the highest recoveries.

This device can handle up to 4 mL sample volumes in swing-bucket rotors and in fixed-angle rotors that accept 15 mL centrifuge tubes.

The Vivaspin® Turbo 4 optimized design and sleek internal profile ensure maximum process speeds all the way down to the last few microliters, resulting in more than 100-fold concentration.

The UV joining technology ensures smooth joint transition between the membrane and the plastic housing – allowing removal of the entire sample concentrated in the unique, pipette-friendly dead-stop pocket.

Technical specifications Vivaspin® Turbo 4

Concentrator capacity

Swing-bucket rotor	4 mL
Fixed-angle rotor	4 mL

Dimensions

Total length	122.5 mm
Width	17 mm
Active membrane area	3.2 cm ²
Hold-up volume of membrane	< 10 µL
Dead-stop volume swing-bucket rotor	40 µL
Dead-stop volume fixed-angle rotor (25°)	60 µL

Materials of construction

Body	Styrene butadiene copolymere
Filtrate vessel	Polypropylene
Concentrator cap	Polypropylene
Membrane	Polyethersulfone

Visit us at

[www.sartorius.com/
VivaspinTurbo4](http://www.sartorius.com/VivaspinTurbo4)
to get additional info.

Find instructions on how to use Vivaspin® Turbo 4 for

- Desalting and buffer exchange
- Preparation of biological nanoparticles and medical nanocarriers
- Concentration and purification of viruses
- Urine protein concentration
- Separation of proteins and metabolites for disease detection

Performance Characteristics

	Time to concentrate up to 30x [min.] at 20°C and solute recovery %			
	Swing out		Fixed angle (25°)	
Rotor	4,000 xg		7,500 xg	
Centrifuge speed	4,000 xg		7,500 xg	
Starting vol.	4 mL		4 mL	
	Min.	Rec.	Min.	Rec.
Cytochrome c (12,400 MW)				
3,000 MWCO PES	60	98%	80	96%
5,000 MWCO PES	40	95%	50	94%
Lysozyme (14,300 MW)				
3,000 MWCO PES	65	95%	70	93%
5,000 MWCO PES	50	94%	60	92%
α-Chymotrypsin (25,000 MW)				
10,000 MWCO PES	10	95%	8	95%
BSA (66,000 MW)				
10,000 MWCO PES	10	98%	7	97%
30,000 MWCO PES	8	96%	6	97%
IgG (160,000 MW)				
30,000 MWCO PES	18	94%	13	92%
50,000 MWCO PES	16	93%	12	90%
100,000 MWCO PES*	17	94%	13	92%

Ordering information

Vivaspin® Turbo 4 Polyethersulfone	Pack size	Prod. no.
3,000 MWCO	25	VS04T91
3,000 MWCO	100	VS04T92
5,000 MWCO	25	VS04T11
5,000 MWCO	100	VS04T12
10,000 MWCO	25	VS04T01
10,000 MWCO	100	VS04T02
30,000 MWCO	25	VS04T21
30,000 MWCO	100	VS04T22
50,000 MWCO	25	VS04T31
50,000 MWCO	100	VS04T32
100,000 MWCO	25	VS04T41
100,000 MWCO	100	VS04T42

* 3,000 xg swing-out | 5,000 xg fixed angle

Vivaspin® 6

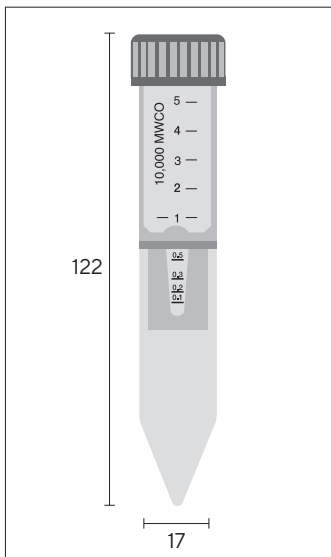

2–6 mL samples

Vivaspin® 6, 6 mL concentrators have been developed to offer increased volume flexibility and performance.

Vivaspin® 6 can process an impressive 6 mL in either swing bucket or fixed angle rotors accepting standard 15 mL conical bottom test tubes.

The Vivaspin® 6 features twin vertical membranes for unparalleled filtration speeds and 100x plus concentrations. Remaining volume is easy to read off the printed scale on the side of the concentrator and the modified dead stop pocket further simplifies direct pipette recovery of the final concentrate.

Technical specifications Vivaspin® 6

Concentrator capacity

Swing bucket rotor	6 mL
Fixed angle rotor	6 mL

Dimensions

Total length	122 mm
Width	17 mm
Active membrane area	2.5 cm ²
Hold-up volume of membrane	< 10 µL
Dead stop volume	30 µL

Materials of construction

Body	Polycarbonate
Filtrate vessel	Polycarbonate
Concentrator cap	Polypropylene
Membrane	Polyethersulfone

Equipment required Vivaspin® 6

Centrifuge

Rotor type	Swing bucket	Fixed angle
Minimum rotor angle	-	25°
Rotor cavity	To fit 15 mL (17 mm) conical bottom tubes	To fit 15 mL (17 mm) conical bottom tubes
Maximum speed	4,000 g	10,000 g*

Concentrate recovery

Pipette type	Fixed or variable volume	Fixed or variable volume
Recommended tip	Thin gel loader type	Thin gel loader type

* Please note, devices with membrane MWCO >100 kDa need to be processed at lower g forces. See data sheets for details.

Performance characteristics

	Time to concentrate up to 30x [min.] at 20°C and solute recovery %			
	Min.	Rec.	Min.	Rec.
Rotor	Swing bucket		25° Fixed angle	
Centrifugal force	3,000 g		7,500 g	
Start volume	6 mL		6 mL	
Cytochrome c 0.25 mg/mL (12,400 MW) 5,000 MWCO PES	-	-	90	97%
BSA 1.0 mg/mL (66,000 MW) 5,000 MWCO PES	20	98%	12	98%
10,000 MWCO PES	13	98%	10	98%
30,000 MWCO PES	12	98%	9	97%
IgG 0.25 mg/mL (160,000 MW) 30,000 MWCO PES	18	96%	15	95%
50,000 MWCO PES	17	96%	14	95%
100,000 MWCO PES	15	91%	12	91%
Latex beads 0.004% in DMEM + 10% FCS (0.055 µm) 300,000 MWCO PES	-	-	25	99%
Latex beads 0.004% in DMEM + 10% FCS (0.24 µm) 1,000,000 MWCO PES	-	-	4	99%
Yeast 1.0 mg/mL (<i>S. Cerevisiae</i>) 0.2 µm PES	4	97%	3	97%

Ordering information

Vivaspin® 6 Polyethersulfone	Pack size	Prod. no.
3,000 MWCO	25	VS0691
3,000 MWCO	100	VS0692
5,000 MWCO	25	VS0611
5,000 MWCO	100	VS0612
10,000 MWCO	25	VS0601
10,000 MWCO	100	VS0602
30,000 MWCO	25	VS0621
30,000 MWCO	100	VS0622
50,000 MWCO	25	VS0631
50,000 MWCO	100	VS0632
100,000 MWCO	25	VS0641
100,000 MWCO	100	VS0642
300,000 MWCO	25	VS0651
300,000 MWCO	100	VS0652
1,000,000 MWCO	25	VS0661
1,000,000 MWCO	100	VS0662
0.2 µm	25	VS0671
0.2 µm	100	VS0672
Starter pack (5 of each 5 k, 10 k, 30 k, 50 k, 100 k)	25	VS06S1

Vivaspin® 15R

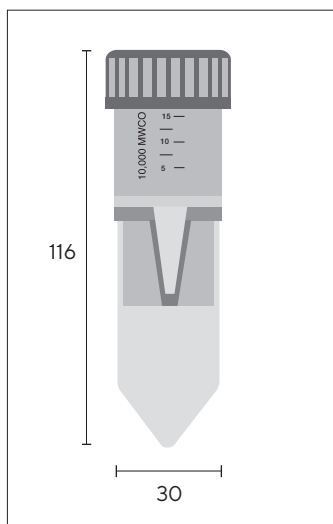

2-15 mL samples

Vivaspin® 15R is the latest member of the Vivaspin® product family with all the unique features of Sartorius Stedim Biotech concentrators including a patented vertical membrane and a dead stop. Vivaspin® 15R is targeting the volume segment 2 to 15 mL with a modified regenerated cellulose membrane; Hydrosart®. This membrane is ideal where extremely high recovery with very low adsorption is needed, for example in applications such as desalting and concentration of immunoglobulin fractions.

- Ultimate recovery at low adsorption (95-98%)
- Extremely short concentration time (30x in 15 min.)
- Convenient application protocol with easy handling
- Easy scale-up to Vivaflow® 200 with Hydrosart® membrane for volumes up to 5 litres
- Very small hold up volume (< 20 µL)

Technical specifications Vivaspin® 15R

Concentrator capacity	
Swing bucket rotor	15 mL
Fixed angle rotor	12.5 mL
Dimensions	
Total length	116 mm
Width	30 mm
Active membrane area	3.9 cm ²
Hold-up volume of membrane	< 20 µL
Dead stop volume	30 µL
Materials of construction	
Body	Polycarbonate
Filtrate vessel	Polypropylene
Concentrator cap	Polycarbonate
Membrane	Hydrosart®

Equipment required Vivaspin® 15R

Centrifuge		
Rotor type	Swing bucket	Fixed angle
Minimum rotor angle	-	25°
Rotor cavity	To fit 50 mL (30 mm) conical bottom tubes	To fit 50 mL (30 mm) conical bottom tubes
Maximum speed	3,000 g	6,000 g
Concentrate recovery		
Pipette type	Fixed or variable volume	Fixed or variable volume
Recommended tip	Thin gel loader type	Thin gel loader type

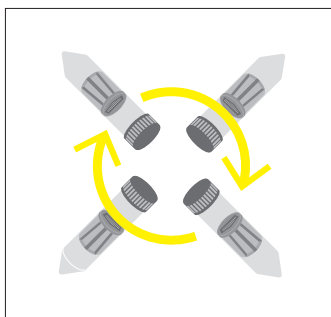

Spin

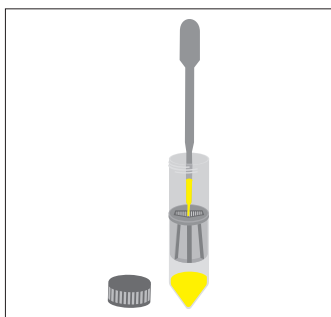

Recover

Performance characteristics

	Time to concentrate up to 30x [min.] at 20°C and solute recovery %			
	Swing bucket		25° Fixed angle	
Rotor	3,000 g		6,000 g	
Centrifugal force	15 mL		12.5 mL	
Start volume	Min.	Rec.	Min.	Rec.
Aprotinin 0.1 mg/mL* (6,500 MW) 5,000 MWCO	47	95%	45	95%
Cytochrome c 0.25 mg/mL* (12,400 MW) 5,000 MWCO	45	96%	45	96%
10,000 MWCO	25	94%	18	94%
α-chymotrypsin 0.25 mg/mL* (25,000 MW) 5,000 MWCO	50	98%	45	98%
10,000 MWCO	25	98%	18	98%
Ovalbumin 1.0 mg/mL* (45,000 MW) 10,000 MWCO	20	98%	14	98%
30,000 MWCO	15	94%	12	94%
BSA 1.0 mg/mL* (66,000 MW) 30,000 MWCO	18	98%	15	98%
IgG 0.1 mg/mL* in DMEM (160,000 MW) 30,000 MWCO	30	98%	25	96%

Ordering information

Vivaspin® 15R Hydrosart®	Pack size	Prod. no.
2,000 MWCO	12	VS15RH91
2,000 MWCO	48	VS15RH92
5,000 MWCO	12	VS15RH11
5,000 MWCO	48	VS15RH12
10,000 MWCO	12	VS15RH01
10,000 MWCO	48	VS15RH02
30,000 MWCO	12	VS15RH21
30,000 MWCO	48	VS15RH22

* Proteins other than IgG made up in 50 mM potassium phosphate, 150 mM sodium chloride, pH 7.4

Vivaspin® Turbo 15 PES

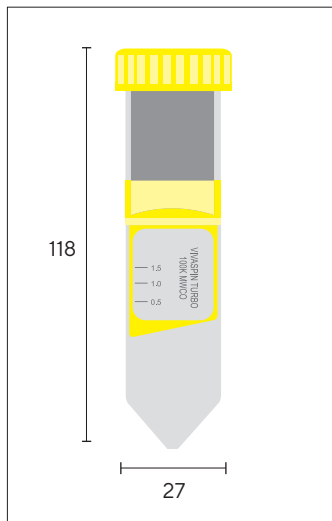

4–15 mL samples

Vivaspin® Turbo 15 PES allows fastest sample concentration with highest recoveries. This device can handle up to 15 mL sample volume in swing bucket rotors and 11 mL in fixed angle rotors accepting 50 mL centrifuge tubes.

The Vivaspin® Turbo 15 PES optimized design and sleek internal profile ensure maximum process speeds right the way down to the last few micro litres leading to > 100 fold concentration.

The Polyethersulfone (PES) membrane employed is made up of stable polymers, suitable for a wide pH and

temperature range. PES membrane is uniquely suited to the retention and recovery of negative charged molecule targets due to it's membrane chemistry.

The UV joining technology allows for a smooth joint transition between membrane and plastic housing, allowing the collection of the complete concentrated sample into the unique pipette friendly dead stop pocket.

Combined with the RC counterpart the Vivaspin® Turbo range offers the best membrane, whatever the sample.

Technical specifications Vivaspin® Turbo 15 PES

Concentrator capacity	
Swing bucket rotor	15 mL
Fixed angle rotor (25°)	11 mL
Dimensions	
Total length (concentrator insert)	77 mm
Total length (in tube with cap)	118 mm
Diameter (concentrator insert)	27 mm
Active membrane area	7.2 cm ²
Hold up volume of membrane	<10 µL
Dead stop volume in swing out	100 µL
Dead stop volume in fixed angle	60 µL
Materials of construction	
Body	Styrene butadiene co-polymer
Filtrate vessel	Polypropylene
Concentrator cap	Polypropylene
Membrane	Polyethersulfone (PES)
Maximum speed	
All rotor types	4000 × g
Sanitization	ETO or 70% EtOH
Removal of endotoxins [Depyrogenization]	Flushing with 1N NaOH

Performance characteristics

	Time to concentrate up to 20x [min.] at 20 °C and solute recovery %			
	Swing bucket		Fixed angle (25°)	
Rotor	Swing bucket		Fixed angle (25°)	
Centrifugal speed	4,000 g		4,000 g	
Start volume	15 mL		11 mL	
	Min.	Rec.	Min.	Rec.
Cytochrome * (12,400 MW) 5 MWCO PES	30	98%	50	98%
Lysozyme* (14,300 MW) 5 MWCO PES	33	96%	50	96%
α-Chymotrypsin** (25,000 MW) 10 MWCO PES	10	95%	10	95%
BSA** (66,000 MW) 10 MWCO PES	10	99%	10	99%
30 MWCO PES	8	98%	10	98%
IgG** (160,000 MW) 30 MWCO PES	23	95%	17	95%

Ordering information

Vivaspin® Turbo 15 Polyethersulfone	Pack size	Prod. no.
3.000	12	VS15T91
3.000	48	VS15T92
5.000	12	VS15T11
5.000	48	VS15T12
10.000	12	VS15T01
10.000	48	VS15T02
30.000	12	VS15T21
30.000	48	VS15T22
50.000	12	VS15T31
50.000	48	VS15T32
100.000	12	VS15T41
100.000	48	VS15T42
300.000	12	VS15T51
300.000	48	VS15T52
1.000.000	12	VS15T61
1.000.000	48	VS15T62
30.000 – 100.000	12	VS15TS1

* 0.25 mg/mL

** 1 mg/mL

Vivaspin® Turbo 15 RC

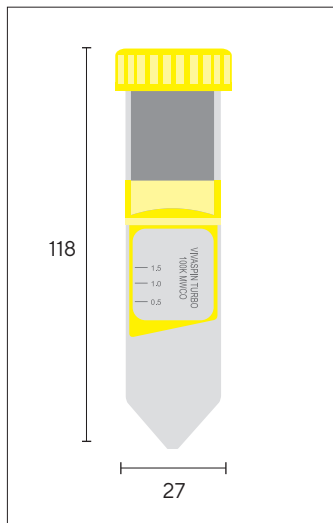

4-15 mL samples

Vivaspin® Turbo 15 RC allows fastest sample concentration with highest recoveries. This device can handle up to 15 mL sample volume in swing bucket rotors and 11 mL in fixed angle rotors accepting 50 mL centrifuge tubes.

The Vivaspin® Turbo 15 RC optimized design and sleek internal profile ensure maximum process speeds right the way down to the last few micro litres leading to > 100 fold concentration.

The hydrophilic Regenerated Cellulose (RC) is suitable for general samples. With ultra-low protein absorption and

high chemical compatibility. The membrane is especially well suited to oligonucleotides and peptides and has been developed uniquely for lab ultrafiltration applications.

The solvent free heat weld technology allows for a smooth transition between the membrane and plastic housing, providing complete sample recovery from the unique pipette friendly dead stop pocket.

Combined with the PES counterpart the Vivaspin® Turbo range offers the best membrane, whatever the sample.

Technical specifications Vivaspin® Turbo 15 RC

Concentrator capacity	
Swing bucket rotor	15 mL
Fixed angle rotor (25°)	11 mL
Dimensions	
Total length (concentrator insert)	77 mm
Total length (in tube with cap)	118 mm
Diameter (concentrator insert)	27 mm
Active membrane area	8.1 cm ²
Hold up volume of membrane	<10 µL
Dead stop volume in swing out	100 µL
Dead stop volume in fixed angle	60 µL
Materials of construction	
Body	Styrene butadiene co-polymer
Filtrate vessel	Polypropylene
Concentrator cap	Polypropylene
Membrane	Regenerated Cellulose (RC)
Maximum speed	
Swing bucket rotor	4000 × g
Swing bucket rotor (100K)	3000 × g
Fixed angle rotor (25°)	6000 × g
Sanitization	ETO or 70% EtOH

Performance characteristics

	Time to concentrate up to 30x [min.] at 20 °C and solute recovery %			
	Swing bucket		Fixed angle (25°)	
Rotor	Swing bucket		Fixed angle (25°)	
Centrifugal speed	4,000 g		6,000 g	
Start volume	15 mL		11 mL	
	Min.	Rec.	Min.	Rec.
Cytochrome * (12,400 MW) 5 MWCO RC	23	94%	37	92%
Lysozyme* (14,300 MW) 5 MWCO RC	23	94%	37	89%
α-Chymotrypsin** (25,000 MW) 10 MWCO RC	7	93%	9	92%
BSA (66,000 MW) 10 MWCO RC**	8	94%	10	98%
30 MWCO RC*	4	96%	4	93%
Gamma Globulin (160,000 MW) 50 MWCO RC**	17	95%	11	96%
100 MWCO RC**	18	89%	12	89%

Ordering information

Vivaspin® Turbo 15 Regenerated Cellulose	Pack size	Prod. no.
5.000	12	VS15TR11
5.000	48	VS15TR12
10.000	12	VS15TR01
10.000	48	VS15TR02
30.000	12	VS15TR21
30.000	48	VS15TR22
50.000	12	VS15TR31
50.000	48	VS15TR32
100.000	12	VS15TR41
100.000	48	VS15TR42

* 0.25 mg/mL

** 1 mg/mL

Vivaspin® 20



5–20 mL samples

Vivaspin® 20 mL centrifugal concentrators have been developed to offer increased volume flexibility and performance.

Vivaspin® 20 handles up to 20 mL in swing bucket centrifuges and 14 mL in 25° fixed angle rotors accepting 50 mL centrifuge tubes.

Featuring twin vertical membranes for unparalleled filtration speeds the Vivaspin® 20 can achieve 100x plus concentrations.

Remaining volume is easy to read off the printed scale on the side of the concentrator and the modified dead stop pocket further simplifies direct pipette recovery of the final concentrate.

More process flexibility

Vivaspin® 20 is available with unique accessories and operating methods that are designed to provide more process flexibility and further time saving.

Gas pressure filtration

When an appropriate centrifuge is unavailable, or for single sample processing, Vivaspin® 20 can be filled with up to 15 mL and then pressurised for bench top concentration. For even faster processing, gas pressure can be combined with centrifugal force. “Pressure-fugation” is particularly suitable for difficult or viscous samples such as serum, or when using a low process temperature which reduces filtration speed, and generally when minimum process time is essential.

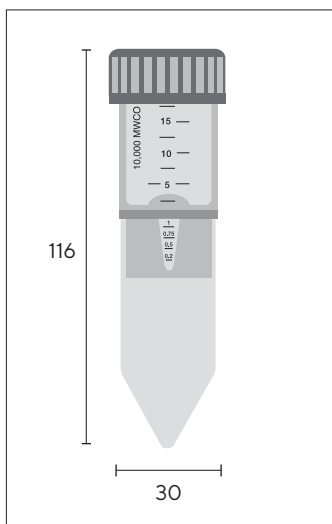

Technical specifications Vivaspin® 20

Concentrator capacity

Swing bucket rotor	20 mL
Fixed angle rotor	14 mL
With pressure head	15 mL

Dimensions

Total length	116 mm 125 mm with pressure head
--------------	-------------------------------------

Width	30 mm
-------	-------

Active membrane area	6.0 cm ²
----------------------	---------------------

Hold-up volume of membrane	< 20 µL
----------------------------	---------

Dead stop volume	50 µL
------------------	-------

Materials of construction

Body	Polycarbonate
Filtrate vessel	Polycarbonate
Concentrator cap	Polypropylene
Pressure head	Acetal aluminium
Membrane	Polyethersulfone

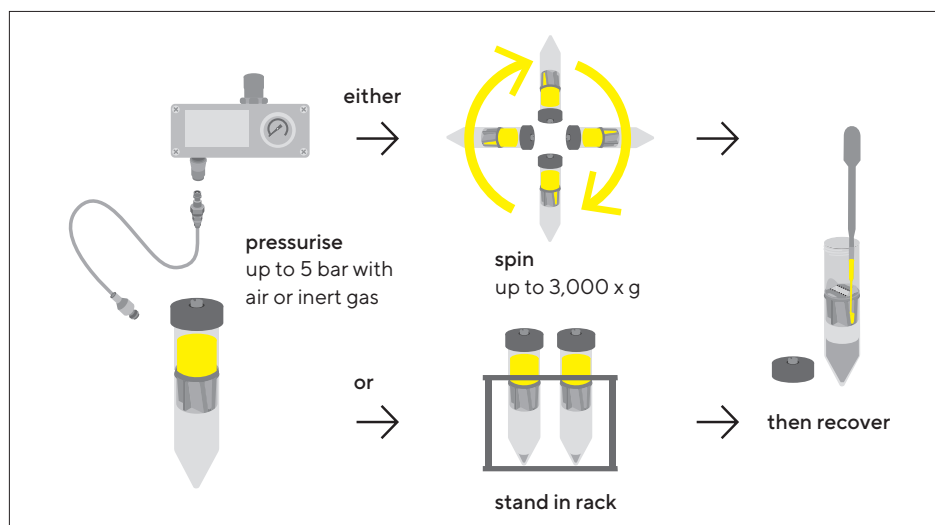

Using the Vivaspin® 20 pressure cap

Desalting with Vivaspin® 20

In this procedure following concentration, a diafiltration cup is filled with buffer and then spun one time to achieve 98% salt removal. This compares to the need for two spins to achieve the same result with the traditional refill and re-spin procedure.

The improved performance is due to the constant washing action of the buffer solution in the diafiltration cup as it replaces solvent and salts as they pass through the ultrafiltration membrane.

Equipment required Vivaspin® 20

Centrifuge		
Rotor type	Swing bucket	Fixed angle
Minimum rotor angle	-	25°
Rotor cavity	To fit 50 mL (30 mm) conical bottom tubes	To fit 50 mL (30 mm) conical bottom tubes
Maximum speed	5,000 g*	8,000 g*
Optional pressure accessories		Prod no.
Air pressure controller (APC) complete with pressure gauge, regulator, over-pressure safety valve, female connector to Sartorius Stedim Biotech pressure products and 1 m extension line (4 mm pneumatic tubing) with male and female connectors and 1 m of 6 mm inlet tubing		VCA002
Charge valve		VCA005
VS20 pressure head		VCA200
Concentrate recovery		
Pipette type	Fixed or variable volume	Fixed or variable volume
Recommended tip	Thin gel loader type	Thin gel loader type

* Please note, devices with membrane MWCO >100 kDa need to be processed at lower g forces. See data sheets for details.

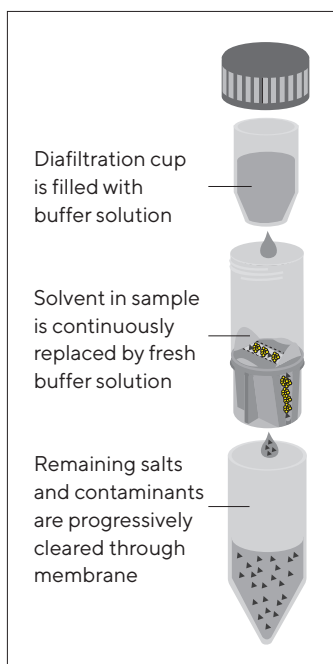

Desalting of concentrated sample

Performance characteristics

	Time to concentrate up to 30x [min.] at 20°C and solute recovery %							
	Centrifuge		Centrifuge		Bench top		Press-fuge	
Mode								
Rotor	Swing bucket		25° Fixed angle		Pressure		Swing bucket	
Centrifugal speed pressure	3,000 g		6,000 g		4 bar		3,000 g + 4 bar	
Start volume	20 mL		14 mL		10 mL		10 mL	
	Min.	Rec.	Min.	Rec.	Min.	Rec.	Min.	Rec.
Cytochrome c 0.25 mg/mL (12,400 MW)								
3,000 MWCO PES	110	97%	180	96%	60	96%	-	-
BSA 1.0 mg/mL (66,000 MW)								
5,000 MWCO PES	23	99%	29	99%	50	98%	14	98%
10,000 MWCO PES	16	98%	17	98%	32	97%	8	97%
30,000 MWCO PES	13	98%	15	98%	32	97%	8	97%
IgG 0.25 mg/mL (160,000 MW)								
30,000 MWCO PES	27	97%	20	95%	46	94%	13	97%
50,000 MWCO PES	27	96%	22	95%	46	93%	13	96%
100,000 MWCO PES	25	91%	20	90%	42	88%	12	94%
Latex beads 0.004% in DMEM +10% FCS (0.055 µm)								
300,000 MWCO PES	20	99%	35	99%	10	99%	-	-
Latex beads 0.004% in DMEM +10% FCS (0.24 µm)								
1,000,000 MWCO PES	4	99%	12	99%	4	99%	-	-
Yeast 1.0 mg/mL (<i>S. Cerevisiae</i>) 0.2 µm PES								
0.2 µm PES	15	95%	5	95%	20	95%	2	95%

Ordering information

Vivaspin® 20 Polyethersulfone	Pack size	Prod. no.
3,000 MWCO	12	VS2091
3,000 MWCO	48	VS2092
5,000 MWCO	12	VS2011
5,000 MWCO	48	VS2012
10,000 MWCO	12	VS2001
10,000 MWCO	48	VS2002
30,000 MWCO	12	VS2021
30,000 MWCO	48	VS2022
50,000 MWCO	12	VS2031
50,000 MWCO	48	VS2032
100,000 MWCO	12	VS2041
100,000 MWCO	48	VS2042
300,000 MWCO	12	VS2051
300,000 MWCO	48	VS2052
1,000,000 MWCO	12	VS2061
1,000,000 MWCO	48	VS2062
0.2 µm	12	VS2071
0.2 µm	48	VS2072
Starter pack (2 of each 5 k, 10 k, 30 k, 50 k, 100 k, 0.2 µm)	12	VS20S1

Vivaspin® 20 accessories

Air pressure controller (APC)	1	VCA002
Charge valve for pressure head	1	VCA005
Diafiltration cups	12	VSA005
Female connector	1	VCA010
Male connector	1	VCA011
4 mm OD pneumatic tube (3 m)	1	VCA012
Vivaspin® 20 pressure head	1	VCA200

Vivaclear Centrifugal Filters



Vivaclear centrifugal filters are disposable microfiltration devices for the fast and reliable clarification/filtration of biological samples in the range 100 µL to 500 µL. They can be used in fixed angle rotors accepting 2.2 mL centrifuge tubes.

Applications

- Clarification of samples before loading onto Vivapure® protein purification spin columns
- Removal of particles and particulates
- Filtration of plasma and serum
- Filtration of cells or cell debris

Product Features

- High-flux Polyethersulphone membrane
- 0.8 µm pore size
- Low hold up volume (<5 µL)
- Fast and reproducible performance

Technical specifications Vivaclear Centrifugal Filters

Rotor	40–45° Fixed angle rotor 500 µL
Pore size	0.8 µm
Dimensions	
Total length	43 mm
Filtrate collection tube diameter	11 mm
Active membrane area	0.34 cm ²
Hold-up volume, membrane plus support	< 5 µL
Maximum RCF	2,000 × g
Materials of construction	
Body	Polypropylene
Membrane	Polyethersulphone
Filtrate collection tube	Polypropylene

Ordering information

Vivaclear Mini	Pack size	Prod. no.
0.8 µm PES	100	VK01P042

Vivacell 100

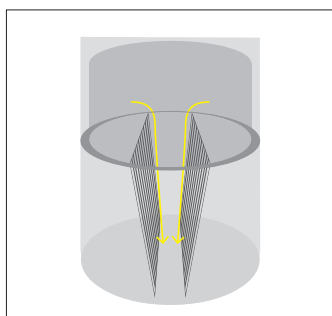

20–100 mL samples

Vivacell 100 bridges the gap between centrifugal concentrators and tangential flow filtration units, but offering both centrifugal and pressure action.

The patented vertical membrane design allows highest performance and unmatched flexibility. Vivacell 100 is a unique and innovative concentrator for volumes from 20 mL to 100 mL, which utilizes pressure, centrifuge or pressure-shake to rapidly concentrate even samples with very high particle loading.

Vivacell 100 is designed for centrifugal concentration of samples up to 100 mL which makes it the largest centrifugal unit available. At the same time, the new construction design allows for maximum centrifugal force of 4,000 × g to be used for even faster concentration.

Vivacell 100 utilizes:

- Pressure
- Centrifuge
- Pressure-shake

Vivacell 100, when used as a centrifugal device, fits only into swing bucket rotors accepting 250 mL bottles.

Vivacell 100 units can also be used for single or extremely sensitive samples in the pressurized mode only and left on the bench or placed on a laboratory shaker for faster concentration. It can also be kept in a pressurized mode in the refrigerator. Handling is made easy by use of quick connectors. In whichever mode Vivacell 100 is used, the vertical membrane design inhibits membrane fouling while the built-in dead stop impedes concentration to dryness and loss of sample.

Technical specifications Vivacell 100

Concentrator capacity	
Swing bucket rotor	90 mL
With pressure head	98 mL
Dimensions	
Total length	123 mm centrifugal 197 mm with pressure head
Width	62 mm
Active membrane area	23.5 cm ²
Hold-up volume of membrane	< 250 µL
Dead stop volume	350 µL
Operating requirements	
Rotor type	Swing bucket
Rotor cavity	To fit 250 mL (62 mm) centrifuge bottles (maximum cavity depth 105 mm)
Maximum speed	2,000 g
Maximum pressure	5 bar (75 psi)
Materials of construction	
Body	Polycarbonate
Filtrate vessel	Polycarbonate
Concentrator cap	Santoprene
Pressure head	Acetal
Membrane	Polyethersulfone

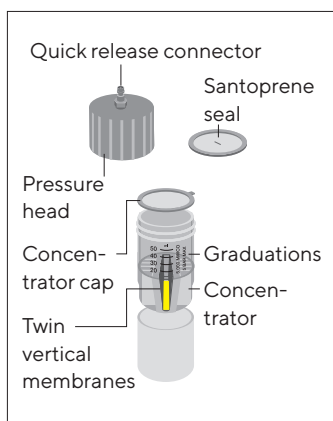

Filtrate container fits standard 250 mL rotors

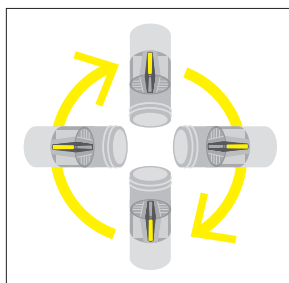

Centrifuge

- Process convenience
- Low shear, no foaming
- Less visual control

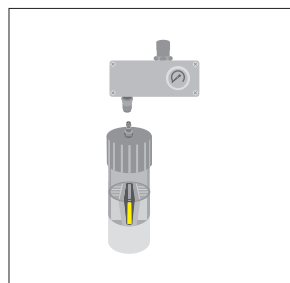

Pressure

- Simplicity and highest process control
- Ideal for refrigerated use
- Slower concentrations

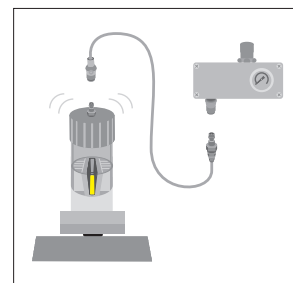

Pressure-shake

- Speed and process control
- Ideal for single samples

Performance characteristics

90 mL start volume	Time to concentrate up to 30x [min.] at 20°C			Solute recovery %
	In centrifuge 2,000 g swing-out rotor	As pressure cell 4 bar (60 psi) pressure		
		No agitation	Orbital shake	
BSA 1.0 mg/mL (66,000 MW)				
5,000 MWCO PES	22	75	25	96%
10,000 MWCO PES	16	60	20	96%
30,000 MWCO PES	16	60	20	94%
IgG 0.25 mg/mL (160,000 MW)				
50,000 MWCO PES	20	70	30	94%
100,000 MWCO PES	20	85	30	90%
Latex beads 0.004% in DMEM + 10% FCS (0.055 µm)				
300,000 MWCO PES	35	-	120	99%
Latex beads 0.004% in DMEM + 10% FCS (0.24 µm)				
1,000,000 MWCO* PES	4	5	4	99%

*2,000 g in centrifuge, 2 bar (29 psi) pressure

Ordering information

Vivacell 100 Polyethersulfone with Polypropylene concentrator cap	Pack size	Prod. no.
5,000 MWCO	2	VC1011
5,000 MWCO	10	VC1012
10,000 MWCO	2	VC1001
10,000 MWCO	10	VC1002
30,000 MWCO	2	VC1021
30,000 MWCO	10	VC1022
50,000 MWCO	2	VC1031
50,000 MWCO	10	VC1032
100,000 MWCO	2	VC1041
100,000 MWCO	10	VC1042
300,000 MWCO	2	VC1051
300,000 MWCO	10	VC1052
1,000,000 MWCO	2	VC1061
1,000,000 MWCO	10	VC1062
0.2 µm	2	VC1071
0.2 µm	10	VC1072

Vivacell 100 accessories

Air pressure controller (APC) complete with pressure gauge, regulator, over-pressure safety valve, female connector, 1 m extension line (4 mm pressure tubing) with male and female connectors and 1 m of 6 mm inlet tubing	1	VCA002
Plastic pipettes	100	VPA005
Female connector	1	VCA010
Male connector	1	VCA011
4 mm pressure tubing (3 m)	1	VCA012
Santoprene replacement seals	10	VCA014
Vivacell 100 pressure head with replacement seals (5)	1	VCA800

Vivaflow® 50

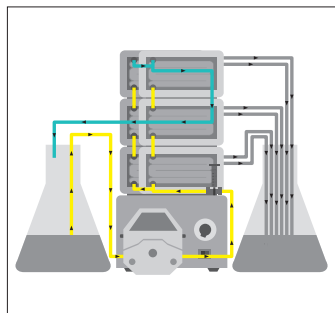
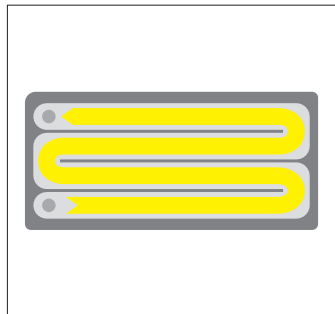

Multiple modules

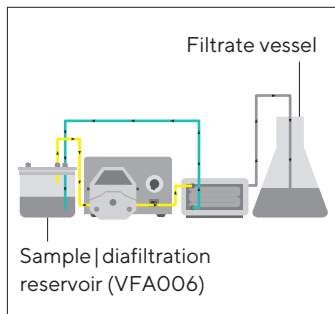

Single module

100 mL to 5 L

The novel Vivaflow® 50 system provides a standard of ease of use, performance, flexibility and economy which is unrivalled by any laboratory or pilot scale filtration system on the market.

Unique features

- Thin channel flip-flow recirculation path provides high cross flow velocities with minimum pump requirements.
- No need for pressure holders.
- Crystal clear for simple control of remaining hold up and membrane status.
- Unique Interlocking modules with series connectors for easy scale up.
- Disposable | single use.

Unique performance

- A single 50 cm² module will typically reduce 500 mL to less than 15 mL in under 50 minutes.
- Less than 10 mL minimum system recirculation for highest concentrations.
- Less than 500 µL non recoverable hold up volume.
- Near total recoveries achievable with a single 10 mL rinse.

Unique “flip-flow” thin channel flow path results in high turbulence and linear velocity for exceptional flux even at high concentrations

Technical specifications Vivaflow® 50

Dimensions

Overall L H W	107 84 25 mm
Channel W H	15 mm 0.3 mm
Active membrane area	50 cm ²
Hold up volume (module)	1.5 mL
Minimum recirculation volume	< 10 mL
Non recoverable hold-up	< 0.5 mL

Operating conditions

Pump flow	200-400 mL/min
Maximum pressure	3 bar (45 psi)
Maximum temperature	60°C

Materials of construction

Main housing	Polycarbonate
Flow channel	TPX (PMP)
Membrane support	TPX (PMP)
Seals and O rings	Silicone
Pressure indicator	Polypropylene, SS spring
Flow restrictor	Polypropylene
Fittings	Nylon
Tubing	PVC (medical grade)



Performance characteristics

	Time to concentrate up to 20x [min.] at 3 bar inlet pressure, 20°C			
	Single device 250 mL start volume	Three devices 1 L start volume	Solute recovery %	
			Direct	10 mL rinse
BSA 1.0 mg/mL (66,000 MW)				
5,000 MWCO PES	34	49	96%	>99%
10,000 MWCO PES	22	32	94%	>99%
10,000 MWCO RC	38	55	96%	>99%
30,000 MWCO PES	22	32	92%	99%
50,000 MWCO PES	20	29	92%	98%
γ Globulins 1.0 mg/mL (160,000 MW)				
100,000 MWCO PES	43	62	92%	98%
100,000 MWCO RC	40	58	92%	98%
Yeast 1.0 mg/mL (<i>S. Cerevisiae</i>)				
0.2 μm PES	33	47	92%	98%

Ordering information

Vivaflow® 50 modules include filtrate tube, size 16 peristaltic tubing, flow restrictor and fittings	Pack size	Prod. no.
3,000 MWCO PES	2	VF05P9
5,000 MWCO PES	2	VF05P1
10,000 MWCO PES	2	VF05P0
30,000 MWCO PES	2	VF05P2
50,000 MWCO PES	2	VF05P3
100,000 MWCO PES	2	VF05P4
1,000,000 MWCO PES	2	VF05P6
0.2 μm PES	2	VF05P7
100,000 MWCO RC	2	VF05C4
Vivaflow® 50 complete system comprises:		
Pump (240 V), Easy load pump head (size 16), tubing, 500 mL sample diafiltration reservoir, module stand, pressure indicator, T connectors, series interconnectors	1	VFS502
Pump (115 V), Easy load pump head (size 16), tubing, 500 mL sample diafiltration reservoir, module stand, pressure indicator, T connectors, series interconnectors	1	VFS504
Vivaflow® 50 PVC tubing and fittings		
Size 16 PVC pump tubing (3 metres, 3.2 × 1.6 mm)		VFA004
Flow restrictor set (2 × 0.4, 0.6, 0.8 mm)		VFA009
T connectors for running 2 stacks (2 pieces)		VFA030
Series interconnectors (6 pieces)		VFA031
Female luer fittings (10 pieces)		VFA032
VF50 tubing Kit (2 × 1 m size 16 PVC tubing with inlet fittings, 2 × 50 cm size 16 PVC tubing with 0.6 mm flow restrictors, 1 × series interconnector)		VFA034
Flow restrictor 0.6 mm (6 pieces)		VFA035

Vivaflow® 50 accessories

Masterflex economy drive variable speed peristaltic pump (240 V)	VFP001
Masterflex economy drive variable speed peristaltic pump (115 V)	VFP002
500 mL sample and/or diafiltration reservoir	VFA006
Masterflex easy load pump head - size 16	VFA012
Vivaflow® 50 stand	VFA016
Pressure indicator (1-3 bar)	VFA020

Vivaflow® 50R

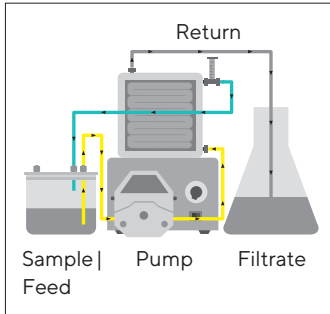

Vivaflow® 50R – Single module

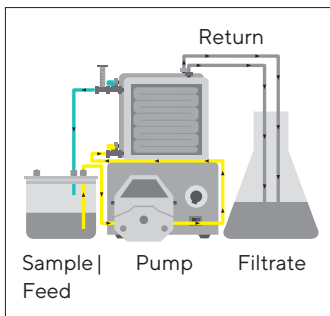

Vivaflow® 50R – Two modules

100 mL to 1 L samples

Concentrate 100 mL to under 20 mL in just a few minutes or concentrate one liter 50 times in less than 60 minutes. Alternatively, speed up your process by using two Vivaflow® 50R units in parallel and concentrate 1 liters in under 30 min.

Vivaflow® 50R is a plug-and-play laboratory crossflow cassette for concentrating up to 1 L aqueous samples. The active membrane area per device is 50 cm².

One unit comes with all the necessary accessories for running the device with a laboratory pump and a size 16 pump head. For speeding up concentration, two cassettes can be run simultaneously.

- Fast and easy protein sample concentration
- Reusable
- Concentrates volumes from 0.1 L to 1 L
- Optimal for concentration of culture supernatants and viruses
- The most compact crossflow cassette with a premium Hydrosart® membrane

Technical specifications Vivaflow® 50R

Dimensions

Overall L × H × W	100 mm × 100 mm × 24 mm
Channel W × H	7.5 mm × 0.4 mm
Active membrane area	50 cm ²
Hold-up volume (module)	1.7 mL
Min. recirculation volume	10 mL
Non-recoverable hold-up	< 0.5 mL

Operating conditions

Pump flow	200 mL/min to 400 mL/min
Maximum pressure	4 bar (60 psi)
Maximum temperature	60°C

Materials of construction

Main housing	Acrylic
Flow channel	Acrylic
Membrane support	Polypropylene
Seals and O-rings	Silicone
Pressure indicator	Polypropylene, SS spring
Flow restrictor	Polypropylene
Fittings	Nylon
Tubing	PVC (medical grade)

Visit us at

www.sartorius.com/

Vivaflow50R

to get additional info.

Here you can find

instructions on how to

use Vivaflow® 50R for

- Preparation of biological nanoparticles and medical nanocarriers
- Concentration and purification of viruses

Performance characteristics

	Time to concentrate up to 20× [min.] at 3.0 bar inlet 2.5 bar outlet pressure, 20°C			
	Start volume 250 mL	Average flux mL/min	Recovery %	
			Direct	25 mL rinse
Lysozyme 0.25 mg/mL (14,000 MW)				
5,000 MWCO Hydrosart®	70	3.4	96%	98%
10,000 MWCO Hydrosart®	23	10.3	94%	96%
BSA 1.0 mg/mL (66,000 MW)				
10,000 MWCO Hydrosart®	24	9.9	98%	>99
30,000 MWCO Hydrosart®	15	15.8	97%	>99
γ Globulins 1.0 mg/mL (150,000 MW)				
100,000 MWCO Hydrosart®	46	5.2	97%	>99
Start volume 1 L (one Vivaflow® 50R at 3 bar), BSA 1.0 mg/mL				
10,000 MWCO Hydrosart®	95	10.0	98%	>99
Start volume 1 L (two Vivaflow® 50R in parallel at 3 bar), BSA 1.0 mg/mL				
10,000 MWCO Hydrosart®	48	19.8	98%	>99

Ordering information

Vivaflow® 50R*	Pack size	Prod. no.
5,000 MWCO Hydrosart®	1	VF05H1
10,000 MWCO Hydrosart®	1	VF05H0
30,000 MWCO Hydrosart®	1	VF05H2
100,000 MWCO Hydrosart®	1	VF05H4
Vivaflow® 50R complete set of accessories		
Pump (230 V), Easy Load pump head (size 16), tubing, 500 mL sample diafiltration reservoir	1	VFS202
Pump (115 V), Easy Load pump head (size 16), tubing, 500 mL sample diafiltration reservoir	1	VFS204
Vivaflow® 50R tubing and fittings		
Size 16 pvc pump tubing and Luer fittings (3 m, 3.2 × 1.6 mm)	1	VFA004
T-connectors for running 2 uni	2	VFA030
Flow restrictor set (2 × 0.4 mm, 0.6 mm, 0.8 mm)	6	VFA009
Female luer fittings – size 16	10	VFA032
Flow restrictors 0.6 mm	6	VFA035
Female luer fittings – size 15	10	VFA036

Vivaflow® 50R accessories

Masterflex economy drive variable speed peristaltic pump (230 V)	1	VFP001
Masterflex economy drive variable speed peristaltic pump (115 V)	1	VFP002
500 mL sample and or diafiltration reservoir	1	VFA006
Masterflex Easy Load pump head – size 16	1	VFA012

* Vivaflow® 50R modules include pressure indicator, flow restrictor and size 16 pvc peristaltic tubing and fittings.

Vivaflow® 200

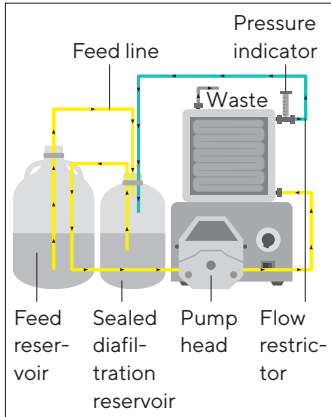

Vivaflow® 200 set-up for diafiltration

0.5 to 5 L

Concentrate 250 mL to under 20 mL in just a few minutes or concentrate one litre 50 times in less than 30 minutes. Alternatively, use two Vivaflow® 200's in parallel and concentrate 5 litres in under 75 minutes.

Near total sample recoveries can be expected with most solutions.

The economical standard package comes complete with tubing, pressure indicator, flow restrictor and high pressure pump tubing. All you need is a peristaltic pump capable of handling 6.4 mm OD (size 16) tubing. Should your pump head require larger tubing, link your own peristaltic tube up to the standard product, using the interconnector provided.

Two modules in parallel will concentrate 5 litres in under 75 minutes.

Technical specifications Vivaflow® 200

Dimensions	
Overall L H W	126 138 38 mm
Channel W H	10 mm 0.4 mm
Active membrane area	200 cm ²
Hold up volume (module)	5.3 mL
Min. recirculation volume	< 20 mL
Non recoverable hold-up	< 2 mL
Operating conditions	
Pump flow	200–400 mL/min
Maximum pressure	4 bar (60 psi)
Maximum temperature	60°C
Materials of construction	
Main housing	Acrylic
Flow channel	Acrylic
Membrane support	Polypropylene
Seals and O rings	Silicone
Pressure indicator	Polypropylene, SS spring
Flow restrictor	Polypropylene
Fittings	Nylon
Tubing	PVC (medical grade)

Performance characteristics

	Time to concentrate up to 20x [min.] at 3 bar inlet pressure, 20°C			
	1 litre start volume	Average flux mL/min	Recovery %	
			Direct	25 mL rinse
Lysozyme 0.25 mg/mL (14,000 MW)				
2,000 MWCO Hydrosart®	160	6	97%	>99%
3,000 MWCO PES	180	5	97%	>99%
BSA 1.0 mg/mL (66,000 MW)				
5,000 MWCO PES	29	33	98%	>99%
5,000 MWCO Hydrosart®	70	14	98%	>99%
10,000 MWCO PES	23	41	96%	>99%
10,000 MWCO Hydrosart®	35	27	98%	>99%
30,000 MWCO PES	25	38	96%	99%
30,000 MWCO Hydrosart®	20	48	96%	>99%
50,000 MWCO PES	22	43	96%	98%
γ Globulins 1.0 mg/mL (average 160,000 MW)				
100,000 MWCO PES	54	18	96%	99%
100,000 MWCO RC	45	21	96%	99%
Yeast 1.0 mg/mL (S. Cerevisiae)				
0.2 μm PES	11	86	92%	98%
Dilute solute concentration, start volume 1 litre at 3 bar, 10,000 MWCO PES				
BSA 0.001 mg/mL	18	52	90%	98%
BSA 0.01 mg/mL	20	47	92%	98%
BSA 0.1 mg/mL	21	45	94%	99%
Start volume 5 litres (two VF200 in parallel at 3 bar) 10,000 MWCO PES				
BSA 1.0 mg/mL (66,000 MW)	67	70	97%	>99%

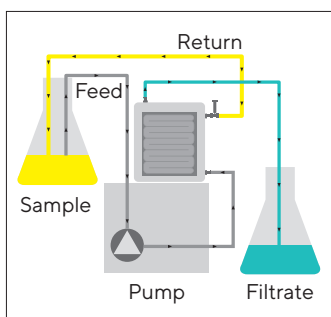

Operation - Single Module

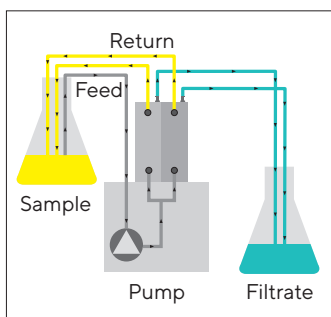

Operation - Two Modules

Ordering information

Vivaflow® 200 modules include pressure indicator, flow restrictor and size 16 pvc peristaltic tubing and fittings	Pack size	Prod. no.
2,000 MWCO Hydrosart®	1	VF20H9
3,000 MWCO PES	1	VF20P9
5,000 MWCO PES	1	VF20P1
10,000 MWCO PES	1	VF20P0
30,000 MWCO PES	1	VF20P2
50,000 MWCO PES	1	VF20P3
100,000 MWCO PES	1	VF20P4
0.2 µm PES	1	VF20P7
100,000 MWCO RC	1	VF20C4
2,000 MWCO Hydrosart®	1	VF20H9
5,000 MWCO Hydrosart®	1	VF20H1
10,000 MWCO Hydrosart®	1	VF20H0
30,000 MWCO Hydrosart®	1	VF20H2

Vivaflow® 200 complete system comprises:

Pump (240 V), Easy load pump head (size 16), tubing, 500 mL sample diafiltration reservoir	1	VFS202
Pump (115 V), Easy load pump head (size 16), tubing, 500 mL sample diafiltration reservoir	1	VFS204

Vivaflow® 200 tubing and fittings

Size 15 pvc pump tubing and Luer fittings (3 m, 4.8 × 2.6 mm)	VFA003
Size 16 pvc pump tubing and Luer fittings (3 m, 3.2 × 1.6 mm)	VFA004
Y connector (size 15 to 2 × size 16)	VFA005
Flow restrictor set (2 × 0.4, 0.6, 0.8 mm)	VFA009
Female luer fittings size 16 (10 pieces)	VFA032
Flow restrictors 0.6 mm (6 pieces)	VFA035
Female luer fittings size 15 (10 pieces)	VFA036

Vivaflow® 200 accessories

Masterflex economy drive variable speed peristaltic pump (240 V)	VFPO01
Masterflex economy drive variable speed peristaltic pump (115 V)	VFPO02
500 mL sample and or diafiltration reservoir	VFA006
Masterflex easy load pump head - size 16	VFA012
Masterflex easy load pump head - size 15	VFA013

Vivapore® Solvent Absorption Concentrators

3 mL–20 mL samples

With no need for additional equipment, pressure or vacuum, solvent absorption is the most economic and user friendly concentration technique available to the clinician and research scientist.

Just fill the unit with the solution to be concentrated, wait for the desired concentration level to be achieved and then pipette the concentrated sample from the bottom of the reservoir.

Vivapore® is ideal for general purpose laboratory concentration or purification prior to further analysis. It is particularly suited for labile solutions that can denature with alternative shear or pressure inducing methods or that require processing in a cold room environment.

Vivapore® concentrators extend the solvent absorption technique to a totally new level of performance, application potential and ease of use.

Technical specifications

	Vivapore® 5	Vivapore® 10 20
Membrane material	PES	PES
Membrane MWCO	7,500	7,500
Membrane surface area	20 cm ²	28 cm ²
Reservoir material	SAN	SAN
Volume range	1–5 mL	2–10 mL 20 mL*
Minimum concentrate volume	50 µL	50 µL
Vivapore® overall dimensions		
Width (mm)	42	46
Height (mm)	82	100

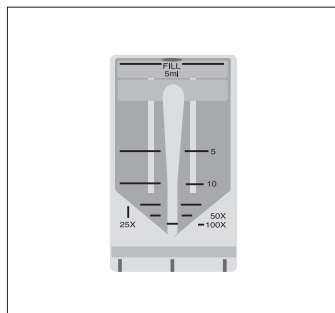

Vivapore® 5

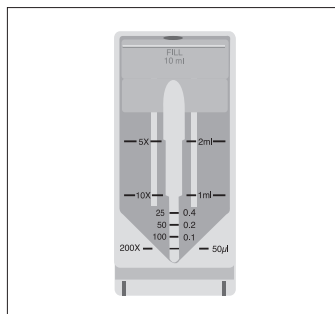

Vivapore® 10|20

* with additional reservoir

Performance characteristics

Product	Time to concentrate up to 10x [min.]			Concentrate recovery %		
	VP5	VP10 20	VP10 20*	VP5	VP10 20	VP10 20*
Start volume	5 mL	10 mL	20 mL	5 mL	10 mL	20 mL
Cytochrome c (12,600 MW)	0.25 mg/mL	0.25 mg/mL	0.1 mg/mL	0.25 mg/mL	0.25 mg/mL	0.1 mg/mL
7,500 MWCO PES	35	75	150	90%	90%	92%
BSA (66,000 MW)						
7,500 MWCO PES	30	55	115	92%	92%	92%
IgG (160,000 MW)						
7,500 MWCO PES	40	70	160	75%	77%	78%

Product	Time to concentrate up to 50x [min.]			Concentrate recovery %		
	VP5	VP10 20	VP10 20*	VP5	VP10 20	VP10 20*
Start volume	5 mL	10 mL	20 mL	5 mL	10 mL	20 mL
Cytochrome c (12,600 MW)						
7,500 MWCO PES	65	70	160	91%	88%	90%
BSA (66,000 MW) 7,500 MWCO PES	45	50	105	90%	90%	92%
IgG (160,000 MW) 7,500 MWCO PES	50	65	140	53%	65%	74%

Ordering information

Vivapore® 5 includes stand and recovery pipettes	Pack size	Prod. no.
7,500 MWCO PES	4	VP0503
7,500 MWCO PES	30	VP0501
Requires stand		
7,500 MWCO PES	100	VP0502
Vivapore® 10 20 includes stand and recovery pipettes		
7,500 MWCO PES	4	VP2003
7,500 MWCO PES	30	VP2001
Requires stand		
7,500 MWCO PES	100	VP2002

Vivapore® accessories

Disposable stands for 4 units	6	VPA002
Plastic recovery pipettes (Vivapore® 10 20)	100	VPA005
10 mL expansion reservoir (Vivapore® 10 20)	10	VPA006
Plastic recovery pipettes (Vivapore® 5)	100	VPA007

* with additional reservoir

Ultrafiltration Membrane Filters

from PES 146..., CTA 145... and RC 144...

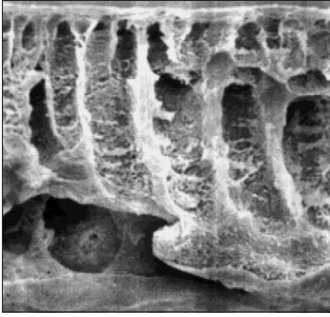

Polyethersulfone (PES)

This is a general purpose membrane that provides excellent performance with most solutions when retentate recovery is of primary importance.

Polyethersulfone membranes exhibit no hydrophobic or hydrophilic interactions and are usually preferred for their low fouling characteristics, exceptional flux and broad pH range.

Cellulose Triacetate (CTA)

High hydrophilicity and very low non-specific binding characterize this membrane. Cast without any membrane support that could trap or bind

passing microsolute, these membranes are to be preferred for sample cleaning and protein removal and when high recovery of the filtrate solution is of primary importance.

Regenerated Cellulose (RC)

These membranes are also highly hydrophilic and are often preferred for their higher protein recovery when processing very dilute solutions. Resistance to autoclaving, ease of cleaning and extended chemical resistance also characterize this type of membrane.

Typical Performance and Specifications

	Polyethersulfone, Type 146	Cellulose Triacetate, Type 145	Regenerated Cellulose, Type 144
Thickness	120 μm	120 μm	180 μm
pH range	1-14	4-8	1-13
Waterflux			
MWCO 10,000	0.2 mL/min/cm ²	0.11 mL/min/cm ²	0.08 mL/min/cm ²
Protein retention			
Cytochrome C	95%	90%	99%

Ordering information

Polyethersulfone Membrane Filters, Type 146	Diameter	Pack size	Prod. no.
5,000 MWCO	25 mm	10	14629--25-----D
10,000 NMGT MWCO	25 mm	10	14639--25-----D
1,000 MWCO	47 mm	10	14609--47-----D
5,000 MWCO	47 mm	10	14629--47-----D
10,000 MWCO	47 mm	10	14639--47-----D
30,000 MWCO	47 mm	10	14659--47-----D
50,000 MWCO	47 mm	10	14650--47-----D
100,000 MWCO	47 mm	10	14668--47-----D
300,000 MWCO	47 mm	10	14679--47-----D
5,000 MWCO	63 mm	10	14629--63-----D
10,000 MWCO	63 mm	10	14639--63-----D
30,000 MWCO	63 mm	10	14659--63-----D
100,000 MWCO	63 mm	10	14668--63-----D
5,000 MWCO	76 mm	10	14629--76-----D
10,000 MWCO	76 mm	10	14639--76-----D
Cellulose Triacetate Membrane Filters, Type 145			
20,000 MWCO	43 mm	10	14549--43-----D
5,000 MWCO	47 mm	10	14529--47-----D
10,000 MWCO	47 mm	10	14539--47-----D
20,000 MWCO	47 mm	10	14549--47-----D
20,000 MWCO	47 mm	10	14549--47-----N
10,000 MWCO	50 mm	10	14539--50-----D
Regenerated Cellulose Membrane Filters, Type 144			
5,000 MWCO	25 mm	10	14429--25-----D
10,000 MWCO	25 mm	10	14439--25-----D
5,000 MWCO	47 mm	10	14429--47-----D
10,000 MWCO	47 mm	10	14439--47-----D
30,000 MWCO	47 mm	10	14459--47-----D
5,000 MWCO	63 mm	10	14429--63-----D
10,000 MWCO	63 mm	10	14439--63-----D
30,000 MWCO	63 mm	10	14459--63-----D
5,000 MWCO	76 mm	10	14429--76-----D
10,000 MWCO	76 mm	10	14439--76-----D



DNA Concentration

Table of Contents

Vivacon® 500	50
Vivacon® 2	53

Vivacon® 500

for DNA sample desalting and concentration



Reproducible DNA and protein sample desalting and concentration

Vivacon® 500 centrifugal concentrators offer the optimal solution for DNA and protein concentration and buffer exchange applications. For optimal performance with very dilute samples, e.g. forensic samples, Vivacon® 500 is equipped with the patented regenerated cellulose membrane Hydrosart®.

High recoveries and excellent reproducibilities are paired with convenience offered by molecular weight cut-off printed on individual devices.

The possibility of a re-spin after sample processing assures complete concentrate recovery which is especially important when working with low sample concentrations.

New: Vivacon® 500-PCR Grade

When using DNA amplification technologies, any traces of DNA originating from the equipment have to be eliminated.

Vivacon® 500-PCR Grade units are treated with ethylene oxide (ETO) in a validated process in order to deactivate all traces of DNA that might interfere with subsequent amplification procedures.

Ref.: K. Shaw et al., Int. J. Legal Med. (2008) 122: 29-33

Feature	Benefit
Re-spin possibility	Complete and highly reproducible sample recovery
Low binding material	High recoveries of low sample concentrations

Technical Specifications Vivacon® 500

Concentrator capacity	
Fixed angle rotor	0.5 mL
Dimensions	
Total length (concentration)	45 mm
Total length (back spin)	47.5 mm
Width	12.4 mm
Active membrane area	0.32 cm ²
Hold up volume of membrane and support	< 5 µL
Dead stop volume (40° rotor)	5 µL
Materials of construction	
Body	Polycarbonate
Filtrate vessel	Polypropylene
Membrane	Hydrosart®

Conversion table for Hydrosart® MWCO to Nucleotide Cut-off

Membrane	MWCO	Double-Stranded Nucleotide Cut-off (bp)
Hydrosart®	2 kDa	> 10
Hydrosart®	10 kDa	> 30
Hydrosart®	30 kDa	> 50
Hydrosart®	50 kDa	> 300
Hydrosart®	100 kDa	> 600

Performance characteristics for DNA

Start volume 0.5 mL, sample concentration 50 ng/mL

	Sample size (bp)	Time to concentrate up to 30x [min.] at 20°C	Concentrate recovery %	g-force (xg)
2,000 MWCO	10	60 min	93%	7,500
10,000 MWCO	30	25 min	94%	7,500
30,000 MWCO	50	18 min	88%	5,000
50,000 MWCO	300	18 min	91%	5,000
100,000 MWCO	600	10 min	87%	3,000

Performance characteristics for proteins

Start volume 0.5 mL, sample and concentration of proteins as specified in table

	Sample	Time to concentrate up to 30x [min.] at 20°C	Concentrate recovery %	g-force (xg)
2,000 MWCO	0.25 mg/mL cytochrome c	30 min	95%	14,000
10,000 MWCO	0.25 mg/mL cytochrome c	15 min	92%	14,000
30,000 MWCO	1.0 mg/mL BSA	10 min	95%	14,000
50,000 MWCO	1.0 mg/mL BSA	10 min	92%	14,000
100,000 MWCO	1.0 mg/mL bovine IgG	11 min	90%	8,000

Ordering information

Vivacon® 500	Pack size	Prod. No.
2,000 MWCO	25	VN01H91
2,000 MWCO	100	VN01H92
10,000 MWCO	25	VN01H01
10,000 MWCO	100	VN01H02
30,000 MWCO	25	VN01H21
30,000 MWCO	100	VN01H22
50,000 MWCO	25	VN01H31
50,000 MWCO	100	VN01H32
100,000 MWCO	25	VN01H41
100,000 MWCO	100	VN01H42
Vivacon® 500 Sample Kit		
Sample Kit L (4 units each of 2, 10, 30 K)	12	VN01HL12
Sample Kit H (4 units each of 30, 50, 100 K)	12	VN01HH12
Vivacon® 500-PCR Grade Sample Pack		
30,000 MWCO	4	VN01H2SETO
50,000 MWCO	4	VN01H3SETO
100,000 MWCO	4	VN01H4SETO
Vivacon® 500-PCR Grade		
30,000 MWCO	25	VN01H21ETO
30,000 MWCO	100	VN01H22ETO
30,000 MWCO	500	VN01H23ETO
50,000 MWCO	25	VN01H31ETO
50,000 MWCO	100	VN01H32ETO
50,000 MWCO	500	VN01H33ETO
100,000 MWCO	25	VN01H41ETO
100,000 MWCO	100	VN01H42ETO
100,000 MWCO	500	VN01H43ETO
Vivacon® 500 accessories		
Tubes	100	VNCT01

Vivacon® 2

for DNA sample desalting and concentration



Reproducible DNA sample desalting and concentration

Vivacon® 2 centrifugal concentrators offer the optimal solution for DNA and protein concentration and buffer exchange applications. For optimal performance with very dilute samples, e.g. forensic samples, Vivacon® 2 is equipped with the patented regenerated cellulose membrane Hydrosart®.

High recoveries and excellent reproducibilities are paired with convenience offered by volume graduation and molecular weight cut-off printed on individual devices.

The possibility of a re-spin after sample processing assures complete concentrate recovery which is especially important when working with low sample concentrations.

New: Vivacon® 2-PCR Grade

Vivacon® 2-PCR Grade units are treated with ethylene oxide (ETO) in a validated process in order to deactivate all traces of DNA that might interfere with subsequent amplification procedures.

Feature	Benefit
Re-spin possibility	Complete and highly reproducible sample recovery
Low binding material	High recoveries of low sample concentration
Easy to remove re-spin cap	Convenient sample handling
Graduation printed on	Optimal process control

Technical Specifications Vivacon® 2

Concentrator capacity	
Fixed angle rotor	2 mL
Dimensions	
Total length (concentration)	125 mm
Total length (back-spin)	115 mm
Width	16 mm
Active membrane area	0.95 cm ²
Hold-up volume membrane and support	10 µL
Dead stop volume (25° rotor)	55 µL
Materials of construction	
Body	Polycarbonate
Filtrate vessel	Polypropylene
Back spin vial	Polypropylene
Concentrator cap	Polypropylene
Membrane	Hydrosart®

Conversion table for Hydrosart® MWCO to Nucleotide Cut-off

Membrane	MWCO	Double-Stranded Nucleotide Cut-off (bp)
Hydrosart®	2 kDa	> 10
Hydrosart®	10 kDa	> 30
Hydrosart®	30 kDa	> 50
Hydrosart®	50 kDa	> 300
Hydrosart®	100 kDa	> 600

Performance characteristics

Volume 2 mL, sample concentration 50 ng/mL, start volume: 2 mL

	Sample size (bp)	Time to concentrate up to 30x [min.] at 20°C	Concentrate recovery %	g-force (xg)
2,000 MWCO	10	120 min	92%	7,500
10,000 MWCO	30	60 min	94%	5,000
30,000 MWCO	50	60 min	95%	2,500
50,000 MWCO	300	45 min	96%	2,500
100,000 MWCO	600	30 min	93%	2,500

Ordering information

Vivacon® 2	Pack size	Prod. No.
2,000 MWCO	25	VN02H91
2,000 MWCO	100	VN02H92
2,000 MWCO	500	VN02H93
10,000 MWCO	25	VN02H01
10,000 MWCO	100	VN02H02
10,000 MWCO	500	VN02H03
30,000 MWCO	25	VN02H21
30,000 MWCO	100	VN02H22
30,000 MWCO	500	VN02H23
50,000 MWCO	25	VN02H31
50,000 MWCO	100	VN02H32
50,000 MWCO	500	VN02H33
100,000 MWCO	25	VN02H41
100,000 MWCO	100	VN02H42
100,000 MWCO	500	VN02H43
Vivacon® 2-PCR Grade		
30,000 MWCO	25	VN02H21ETO
30,000 MWCO	100	VN02H22ETO
30,000 MWCO	500	VN02H23ETO
50,000 MWCO	25	VN02H31ETO
50,000 MWCO	100	VN02H32ETO
50,000 MWCO	500	VN02H33ETO
100,000 MWCO	25	VN02H41ETO
100,000 MWCO	100	VN02H42ETO
100,000 MWCO	500	VN02H43ETO
Vivacon® 2-PCR Grade Sample Pack		
30,000 MWCO	4	VN02H2SETO
50,000 MWCO	4	VN02H3SETO
100,000 MWCO	4	VN02H4SETO



Protein Purification

Table of Contents

Vivapure® Ion Exchange Protein Purification Products

58

Vivapure® Ion Exchange Protein Purification Products

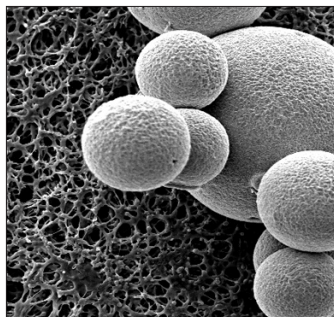

Chromatography gel beads (right) are shown on top of a membrane adsorber in this SEM picture. The membrane adsorber pores are over 50 + larger than bead pores.

Fast and easy-to-use spin columns
Vivapure® Ion Exchange (IEX) spin columns are centrifugal devices, incorporating Sartobind® Membrane Adsorber technology as their chromatography matrix. Vivapure® IEX spin columns make protein purification as easy as filtration. The devices are ready-to-use and do not bear the risk of running dry. For many protein purification applications, they can replace time-consuming and tedious column chromatography.

The rapid 1-2-3 bind-wash-elute protocol especially lends itself to screening applications, where many different samples are processed in parallel.

The Sartobind® membrane adsorber matrix

Sartobind® IEX membrane adsorbers are based on stabilized regenerated cellulose and display a microporous structure with a pore size of $> 3 \mu\text{m}$, which is orders of magnitude larger than conventional chromatographic gel materials. This allows molecules to be transported to the ligands immobilized on the membrane adsorber by convective flow, leading to very high flow rates.

In contrast to that, gel chromatography is slowed down due to diffusion limitations, as the molecules need to enter the small bead pores in order to be bound by the ligands. The porous membrane adsorber enables fast, reproducible and scalable protein purification.

Fast and simple to use spin columns

- Devices are ready to use
- Make protein purification as simple as filtration

Reproducible results

- No column packing necessary devices are ready-to-use
- Membrane adsorber spin columns cannot crack or run dry

Centrifugal devices

- Offer the possibility of working in parallel

Low bed volume

- Small membrane adsorber bed volumes allow working with lower buffer amounts, leading in concentrated elution fractions

Up-scalable product range

- Process scale modules are available with the same Sartobind® IEX membrane adsorber matrix

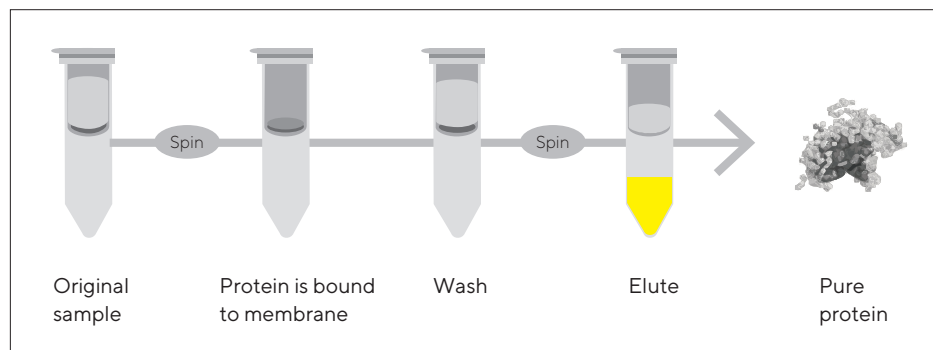

Fast and easy protein purification with Vivapure® spin columns



Vivapure® Mini-400 | 500 µL
Binding capacity: 1-4 mg



Vivapure® Maxi-19 | 20 mL
Binding capacity: 15-80 mg

Available formats

Vivapure® IEX Products	Application
Vivapure® Mini Spin Columns	<ul style="list-style-type: none"> Sample fractionation Purification condition scouting Small scale purification
Vivapure® Maxi Spin Columns	<ul style="list-style-type: none"> Large scale sample fractionation One step protein purification concentration Polishing of his-tagged protein

Membrane availability

Functional groups	Ion exchanger type
Sulphonic acid (S)	Strong acidic cation exchanger: R-CH ₂ -SO ₃ ⁻ Na ⁺
Quaternary ammonium (Q)	Strong basic anion exchanger: R-CH ₂ -N ⁺ -(CH ₃) ₃ Cl ⁻
Diethylamine (D)	Weak basic anion exchanger: R-CH ₂ -NH ⁺ -(CH ₂ H ₅) ₂

Performance characteristics

Vivapure® spin columns	Protein binding capacity* (mg)	Max. volume per centrifuge run using a swing-out rotor (mL)	Max. volume per centrifuge using a fixed angle rotor run (mL)
Vivapure® Mini H	4	0.4	
Vivapure® Maxi H	60-80	19	10.5

Typical Applications

- Fractionation prior to further analysis e.g. 2D gels
- Scouting purification conditions for new protein preparation protocols
- Endotoxin removal
- Polishing His-tagged proteins after metal chelate chromatography
- Purification and concentration of proteins
- Removal of heme moiety from heme containing proteins

Detailed application notes are available on our website: www.sartorius.com

Ordering Information

Vivapure® Mini Ion Exchange Spin Columns (up to 0.5 mL)	Spin Columns	Centrifuge Tubes	Prod. no.
Vivapure® Mini S&Q H starter kit	16	32	VS-IX01SQ16
Vivapure® D Mini H	24	48	VS-IX01DH24
Vivapure® Q Mini H	24	48	VS-IX01QH24
Vivapure® S Mini H	24	48	VS-IX01SH24
Vivapure® Maxi Ion Exchange Spin Columns (up to 20 mL)			
Vivapure® D Maxi H	8	16	VS-IX20DH08
Vivapure® Q Maxi H	8	16	VS-IX20QH08
Vivapure® S Maxi H	8	16	VS-IX20SH08

* Actual yields depend on specific protein sample and selected pH and salt conditions. Yields established using 1 mg/mL BSA in 25 mM Tris/HCL pH 8.0 with Vivapure® Q & D spin columns and 1 mg/mL cytochrome c in 25 mM sodium acetate buffer pH 5.5 with Vivapure® S spin columns.

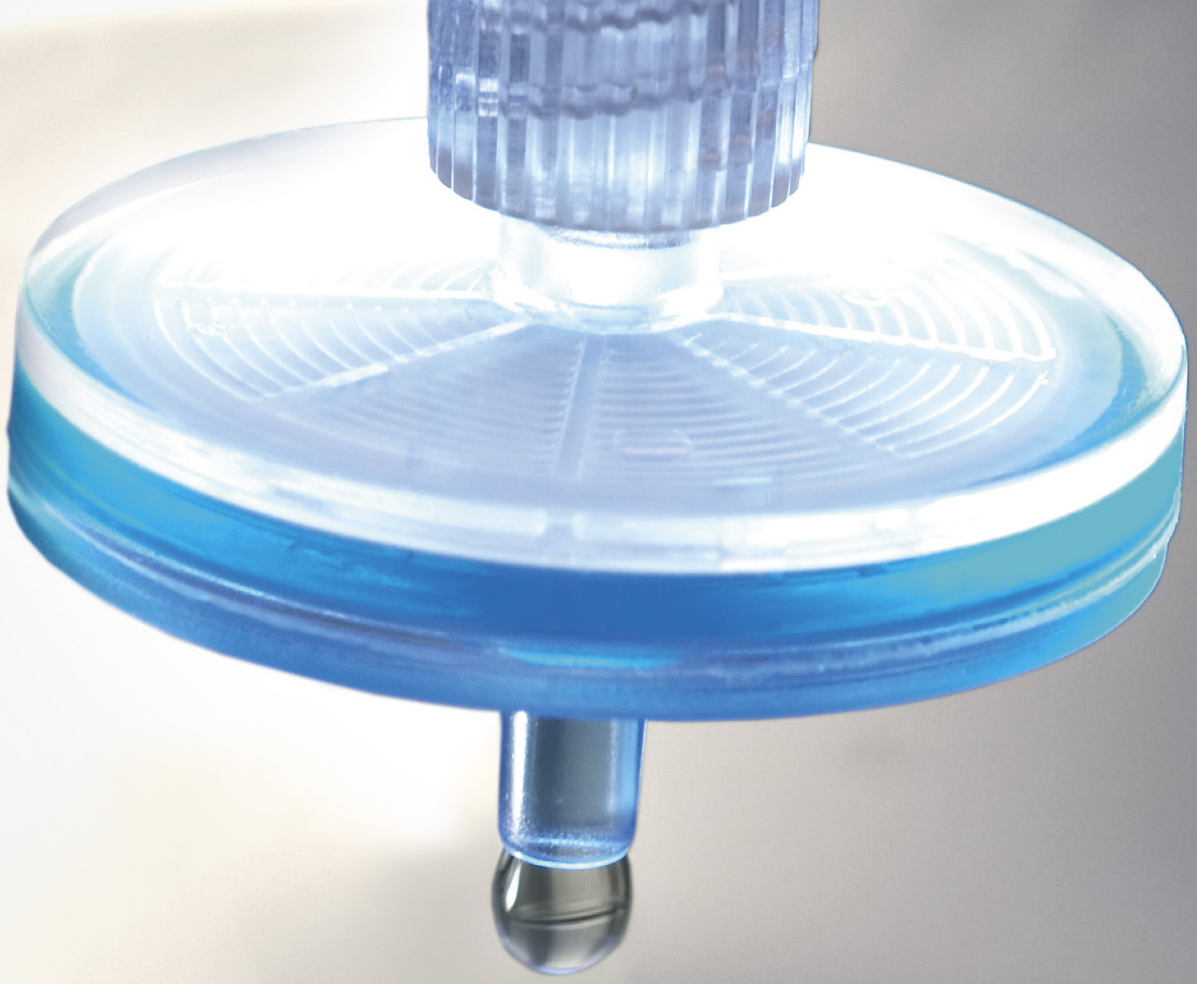

Virus Purification and Concentration

Table of Contents

Vivapure® Virus Purification and Concentration Kits	62
Adenovirus Purification with Vivapure® AdenoPACK kits	63
Vivapure® AdenoPACK 20	64
Vivapure® AdenoPACK 100	65
Vivapure® AdenoPACK 500	67
Lentivirus Purification with Vivapure® LentiSELECT Kit	68
Vivapure® LentiSELECT 40	69
Vivapure® LentiSELECT 500	70
Vivapure® LentiSELECT 1000	71

Vivapure® Virus Purification and Concentration Kits



Recombinant virus vectors are the preferred method for a wide range of gene delivery applications. Especially adenovirus type 5 and VSV-G pseudotyped lentivirus are two frequently utilized viral vectors for in vitro and in vivo applications.

Recombinant adenovirus vectors

Recombinant adenovirus vectors are versatile tools in research and therapeutic applications for gene transfer and protein expression in cell lines that have low transfection efficiency with liposomes.

After entering cells, the virus remains epichromosomal (i.e. does not integrate into the host chromosome, leaving the host genome unaffected). The delivery of RNAi into cells is becoming a major application for adenovirus vectors.

Lentivirus vectors

Lentivirus vectors are frequently used in gene transfer studies, due to their ability of gene transfer and integration into dividing and non-dividing cells. The pseudotyped envelope with vesicular stomatitis virus envelope G (VSV-G) protein broadens their target cell range. Lentiviral vectors have been shown to deliver genes into cell types (e.g. neurons, lymphocytes and macrophages) which other retrovirus vectors could not be used for. The lentivirus vector is increasingly used to integrate siRNA efficiently in a wide variety of cell lines and primary cells, both in vitro and in vivo.

Rapid virus purification by Membrane Chromatography

The Sartobind® ion exchange membrane adsorber technology used in AdenoPACK and LentiSELECT is unique in its capability to efficiently and rapidly capture and recover large virus particles. When compared to chromatography media, membrane adsorbers provide large 3000 nm pores allowing unrestricted access and recovery of virus from the charged adsorber surface. Convective flow through the syringe filter devices provides high-speed separations not possible with traditional chromatography, cesium chloride density gradients and ultracentrifugation methods.

Our membrane adsorbers with porous matrices, high capacities, low differential pressures, high flow rates and low unspecific adsorption show an excellent performance in small scale virus purification. Additionally, they are also scalable and confirm to cGMP facilities to large volume, high performance separation, reducing the processing time by a factor of 10 in the final process.

Adenovirus Purification with Vivapure® AdenoPACK Kits

AdenoPACK 20 | 100 | 500

The AdenoPACK adenovirus purification and concentration kits offer researchers who need to recover up to 3×10^{13} purified recombinant adenovirus particles for invitro transfection a fast, safe and easy to use solution. The kits include all reagents and devices necessary for clarification, purification and concentration of adenovirus type 5 from HEK293 cell cultures in only two hours. These straight forward kits replace time-consuming and labor-intensive 48 hour CsCl density gradients.

AdenoPACK kits are offered as AdenoPACK 20, AdenoPACK 100 and AdenoPACK 500, for the purification and concentration of adenovirus type 5 from 20 mL to 500 mL cell culture, leading to 1×10^{11} - 3×10^{13} purified viral particles. For each sample volume, the most convenient handling method is offered for ultimate convenience.

To this end, preparations using AdenoPACK 20 are pursued in spin column format in a centrifuge, AdenoPACK 100 is a manually operated kit in syringe filter format*, and AdenoPACK 500 is a pump driven kit.

AdenoPACK advantages

Fast and easy virus purification

- Purification completed in 2 hours
- Convenient, over 10 × faster alternative to CsCl density gradient

Quantitative yields

- In contrast to CsCl density gradient, the complete cell culture is used for virus purification and not only the viral pellet

Flexible product range

- Applicable from initial construct screening to large scale virus production

Complete Kit

- Including filtration devices, AdenoPACK units for virus purification, Vivaspin® and all buffers

Low endotoxin levels

- High cell viability and infection rates due to endotoxin levels of <0.025 EU/mL

Purification results from preparations with Ad5 GFP-constructs

Purification method	Process time	Eluate	Recovery***	Viral Particles
AdenoPACK 20 20 mL culture	1 hour	1 mL	65–70%	$1 \times 10^{11-12}$
AdenoPACK 100 60 mL culture	1-2 hours	1 mL	65%	$1-3 \times 10^{12}$
AdenoPACK 100 200 mL culture	2 hours	1 mL	80%	1×10^{13}
AdenoPACK 500 500 mL culture	2 hours	1 mL	80%	$1-3 \times 10^{13}$
500 mL CsCl density gradient	24–48 hours	1–2 mL**	60–70%	$1 \times 10^{11-12}$

* Vivapure® AdenoPACK 100 can optionally be operated with a laboratory pump and an infusion pump, for which protocols are provided on our web page www.sartorius.com. Additionally, the tubes and adaptors needed for these operation modes can be ordered.

** after dialysis

*** before buffer exchange

Vivapure® AdenoPACK 20

The optimal kit for construct screening



Vivapure® AdenoPACK 20 is the downscale kit in the AdenoPACK series, purifying up to 1×10^{12} adenovirus type 5 particles from 20 mL cell culture. Especially when testing new constructs, parallel and fast purifications of different adenoviruses are essential. This kit allows the rapid, simple and affordable spin column based purification of 6 different samples in

parallel and bridges a gap in the CsCl density gradient method – for the first time adenovirus type 5 can efficiently be purified from less than 100 mL cell culture volume!

Typical performance

For a normal yielding vector, 1×15 cm culture plate purified using this method yields up to 1×10^{12} viral particles.

Vivapure® AdenoPACK 20 contents and ordering information

Vivapure® AdenoPACK 20	VS-AVPQ020
Vivapure® AdenoPACK 20 RT*	VS-AVPQ022
AdenoPACK Maxi spin columns	6
Vivaclear Maxi 0.45 µm PES	6
Empty 50 mL tubes	6
Loading Buffer (10×)	25 mL
Washing Buffer (10×)	30 mL
Elution Buffer	20 mL
Benzonase® (12.5 U/µL)	120 µL
Vivaspin® 20, 100 kDa MWCO	6
Instructions	1 each for Kit and Vivaspin®

Technical data

Kit specifications

Sample size	20 mL of cell culture
Number of purifications	6×20 mL
Virus particles (VP) per mL	Typically up to $1 \times 10^{11} - 10^{12}$
VP IU	50-100
Processing time	Typically 1 hour
Endotoxin level	< 0.025 EU/mL

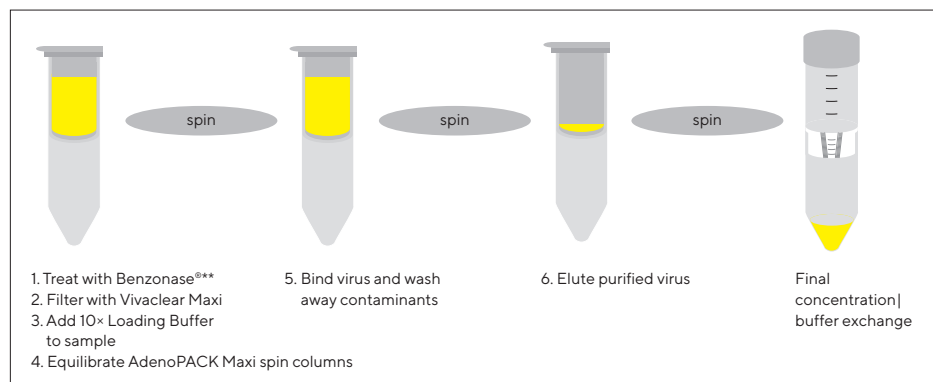

* AdenoPACK 20 RT does not contain Benzonase®

** Benzonase® Nuclease is manufactured by Merck KGaA, Darmstadt, Germany and is covered by US Patent 5,173,418 and EP Patent 0,229,866. Nycomed Pharma A/S (Denmark) claims worldwide patent rights to Benzonase® Nuclease, which are licensed exclusively to Merck KGaA, Darmstadt, Germany. Benzonase® is a registered trademark of Merck KGaA, Darmstadt, Germany.

Vivapure® AdenoPACK 100

Fast purification of up to 1×10^{13} viral particles



Vivapure® AdenoPACK100 is optimally suited for adenovirus purification from up to 200 mL cell culture for in vitro transfection. This flexible kit contains two AdenoPACK 100 units, which can be either used in tandem for the purification of up to 200 mL cell culture for recovering 1×10^{13} viral particles or individually for purifying $1-3 \times 10^{12}$ viral particles from up to 60 mL cell culture. The purification is pursued manually with a syringe optimally attached to a retort stand.

However, for even more convenience, protocols are provided for optionally running the virus purification with a peristaltic pump or with an infusion pump, in addition to detailed instructions for a manual operation supplied with the kit. The accessories needed for the operation with a pump are supplied as individual products.

Typical performance

For a normal yielding vector, 10×15 cm culture plate purified using this method yields up to 1×10^{13} viral particles.

Vivapure® AdenoPACK 100 contents and ordering information

Vivapure® AdenoPACK 100	VS-AVPQ101
Vivapure® AdenoPACK 100 RT*	VS-AVPQ102
AdenoPACK 100 units	2
Minisart® Plus	4
20 mL syringe	4
Tubing set and one way valve	2
10 mL syringe (elution)	2
Loading Buffer (10×)	1 × 25 mL
Washing Buffer	1 × 120 mL
Elution Buffer	1 × 20 mL
Benzonase® 12.5 U/μL	200 μL
Vivaspin® 20 concentrator	4
Instructions	1 each for Kit and Vivaspin®

AdenoPACK 100 accessories

Pump tubing set for Vivapure® AdenoPACK100	VS-AVPA001
--	------------

* AdenoPACK 100 RT does not contain Benzonase®*

Technical data

Kit specifications

Sample size	20–200 mL of cell culture
Number of purifications	2 × 20–60 mL 1 × 200 mL
Virus particles (VP) per mL	Typically up to 1×10^{13}
VP IU	20–50
Processing time	Typically 2 hours
Endotoxin level	< 0.025 EU/mL

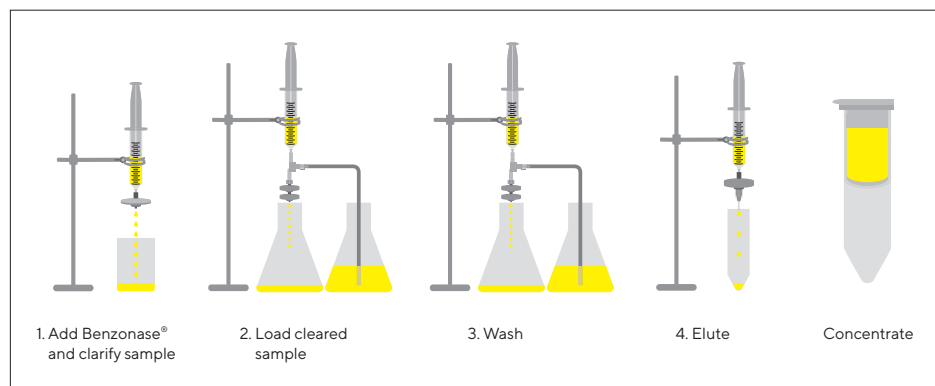

Vivapure® AdenoPACK 500

Pump driven kit for larger volumes



Vivapure® AdenoPACK 500 is the direct upscale kit to the AdenoPACK 100, for adenovirus purification. In only 2 hours up to 3×10^{13} adenovirus particles are purified and concentrated from 500 mL cell culture. This completely ready-to-use kit is conveniently operated by a laboratory pump, offering optimal flow control and minimal

hands-on time. This easy to use product replaces lengthy and inefficient cesium chloride density gradient methods.

Typical performance

For a normal yielding vector, 25×15 cm culture plate purified using this method yields up to 3×10^{13} viral particles.

Vivapure® AdenoPACK 500 contents and ordering information

Vivapure® AdenoPACK 500	VS-AVPQ501
Vivapure® AdenoPACK 500 RT*	VS-AVPQ502
AdenoPACK 500 unit	1
Sartopore 2 150	1
Tubing set and one way valve	2
10 mL syringe	1
Loading Buffer (10×)	60 mL
Washing Buffer (10×)	30 mL
Elution Buffer	20 mL
Benzonase® 12.5 U/μL	500 μL
Vivaspin® 20 concentrator	2
Instructions	1 each for Kit and Vivaspin®

Technical data

Kit specifications

Sample size	500 mL of cell culture
Number of purifications	1 × 500 mL
Virus particles (VP) per mL	Typically up to 3×10^{13}
VP IU	20-50
Processing time	Typically 2 hours
Endotoxin level	< 0.025 EU/mL

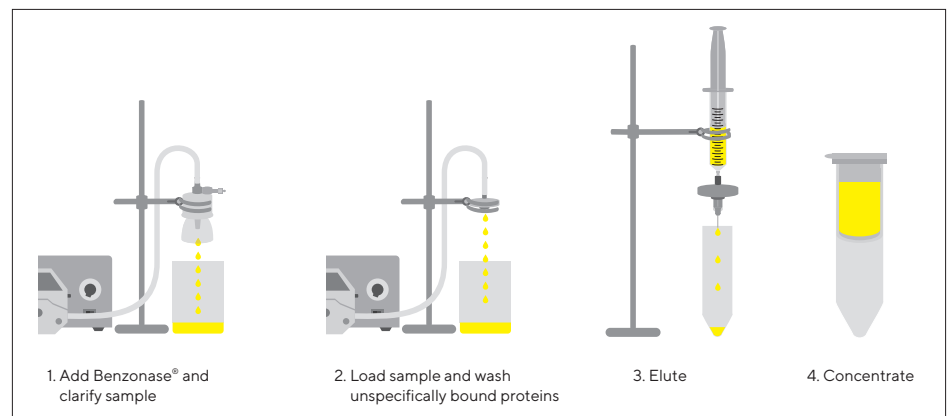

* AdenoPACK 500 RT does not contain Benzonase®

Lentivirus Purification with Vivapure® LentiSELECT Kit

LentiSELECT 40 | 500 | 1000

The LentiSELECT lentivirus purification and concentration kits offer researchers who need to recover up to 5×10^9 infective lentivirus particles per mL for invitro transfection or animal studies a fast and easy to use solution.

These straight forward kits replace time-consuming ultracentrifugation protocols, which typically take approximately one day for large sample volumes, thus reducing the purification time to only a few hours.

LentiSELECT kits are offered as LentiSELECT 40, LentiSELECT 500 and LentiSELECT 1000 for the purification and concentration of VSV-G pseudotyped lentivirus from 40 mL to 1000 mL cell culture, leading to $8 \times 10^8 - 1 \times 10^{10}$ purified infective particles. For each sample volume, the most convenient handling method is offered. To this end, 40 mL sample volumes are processed manually with LentiSELECT 40, while LentiSELECT 500 and 1000 are pump driven kits.

LentiSELECT advantages

Fast and easy virus purification

- Purification completed in under one to six hours, depending on sample volume
- Kit as easy to use as filtration

No need for expensive instruments

- Lentivirus purification with LentiSELECT is independent of equipment such as ultracentrifuges

High virus purity

- Achieve pure virus due to a chromatography purification for your experiments instead of a crude and variable cell culture supernatant pellet

Optimal for multiple virus construct screening

With LentiSELECT 40, four purification runs can be conducted in parallel with one kit

Complete Kits

- Including LentiSELECT units for virus purification, Vivaspins for concentration | buffer exchange and all buffers and syringes necessary

Low endotoxin levels

- High cell viability and infection rates due to endotoxin levels of <0.025 EU/mL

Purification results from preparations with VSV-G pseudotyped lentivirus constructs

Purification method	Process time	Eluate	Viral Particles/mL	Recovery	Infective Viral Particles
LentiSELECT 40 40 mL sample	45 min	200 μ L*	4×10^9	50%	8×10^8
LentiSELECT 500 500 mL sample	3 hours	1 mL*	3×10^9	35%	$2-5 \times 10^9$
LentiSELECT 1000 1000 mL sample	6 hours	2 mL*	5×10^9	35%	1×10^{10}
Ultracentrifugation 500 mL sample	10-11 hours	500 μ L	6×10^9	25%	3×10^9

* After desalting | buffer exchange

Vivapure[®] LentiSELECT 40

Fast purification of up to 8×10^8 viral particles



Vivapure[®] LentiSELECT 40 is optimally suited for lentivirus purification for up to 40 mL cell culture and contains all components necessary for 4 purifications. Up to 8×10^8 viral particles are recovered in less than one hour. In contrast to traditional ultracentrifugation methods, virus purification with Vivapure[®] LentiSELECT is fast and simple, without the need for expensive equipment like an ultra-

centrifuge. Additionally, this chromatographic procedure leads to pure virus samples in contrast to the crude ultracentrifuge pellet, resulting in higher reproducibility and increased gene transfer efficiency.

Typical performance

For a normal yielding vector, 2×15 cm culture plate purified using this method yield up to 8×10^8 particles.

Vivapure[®] LentiSELECT 40 contents and ordering information

Vivapure [®] LentiSELECT 40	VS-LVPQ040
LentiSELECT units	4
50 mL syringe	4
10 mL syringe	4
Tube set with one-way valve	4
Loading buffer (10 ×)	30 mL
Washing buffer	150 mL
Elution buffer	20 mL
Vivaspin [®] 20, 100 kDa MWCO	8
Instructions	1 each for Kit and Vivaspin [®]

Technical data

Kit specifications

Sample size	40 mL cell culture
Number of purifications	4×40 mL
Infective particles (P) per mL	Typically up to 3×10^9
VP IU	5–15
Processing time	Typically 45 minutes
Endotoxin level	< 0.025 EU/mL

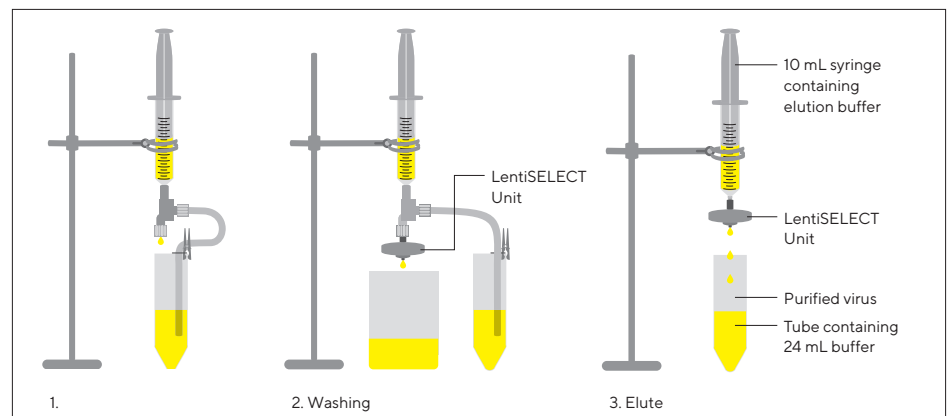

Vivapure® LentiSELECT 500

Fast purification of up to $2-5 \times 10^9$ infective particles per mL from 500 mL cell culture



Vivapure® LentiSELECT 500 is optimally suited for VSV-G pseudotyped lentivirus purification from up to 500 mL cell culture and contains all reagents and devices necessary for purifying up to $2-5 \times 10^9$ infective particles.

The whole purification procedure is simply operated by a laboratory pump, which minimizes hands-on time. Unlike conventional purification

methods as ultracentrifugation, Vivapure® LentiSELECT 500 offers a fast and simple solution for purifying VSV-G pseudotyped lentiviruses making expensive purification equipment like ultracentrifuges redundant.

Typical performance

For a normal yielding vector, 500 mL cell culture purified using this method yield up to $2-5 \times 10^9$ infective particles in 1 mL (total volume 1 mL).

Vivapure® LentiSELECT 500 contents and ordering information

Vivapure® LentiSELECT 500	VS-LVPQ500
LentiSELECT unit	1
Sartopore® 2 150	1
50 mL syringe	1
Tube set with one-way valve	1
Loading buffer (10 ×)	30 mL
Washing buffer	170 mL
Elution buffer	30 mL
Vivaspin® 20, 100 kDa MWCO	2
Operating manual	1 each for Kit and Vivaspin®

Technical data

Kit Specifications

Sample size	500 mL cell culture
Number of purifications	1 × 500 mL
Infective particles (IP) per mL	Typically up to $2-5 \times 10^9$ *
Processing time	Typically up to 3 hours
Endotoxin level	< 0.025 EU/mL

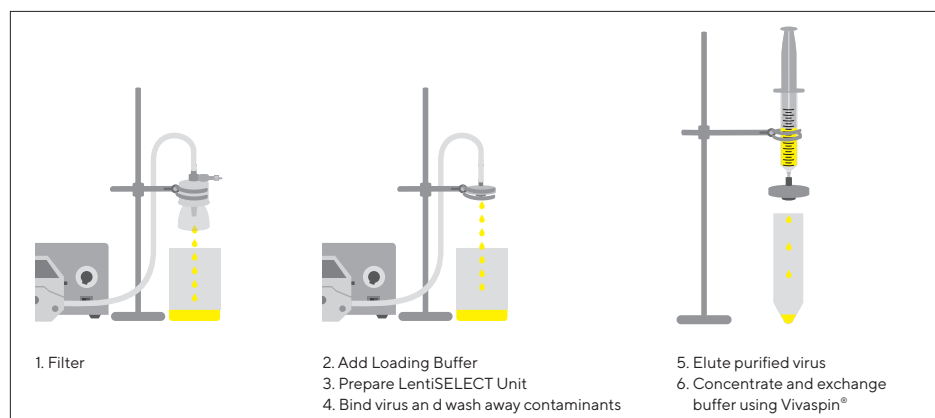

*1 mL final elution sample

Vivapure® LentiSELECT 1000

Pump driven kit for larger sample volumes



Vivapure® LentiSELECT 1000 is the direct scale up kit to LentiSELECT 500, for VSV-G pseudotyped lentivirus purification. The rapid 6 hour protocol results in a recovery of $4-5 \times 10^9$ infective particles per mL (total volume 2 mL) from 1000 mL cell culture supernatant.

This kit is to be operated by a laboratory pump and contains all necessary buffers and ultrafiltration devices for

optimal convenience. The traditional time consuming ultracentrifugation method is replaced by this fast and simple Vivapure® LentiSELECT 1000 kit.

Typical performance

For a normal yielding vector, 1000 mL cell culture purified using this method yield up to $4-5 \times 10^9$ infective particles in 1 mL (total volume 2 mL).

Vivapure® LentiSELECT 1000 contents and ordering information

Vivapure® LentiSELECT 1000	VS-LVPQ1000
LentiSELECT unit	2
Sartopore® 2 150	1
50 mL syringe	1
Tube set with one-way valve	1
Loading buffer (10 ×)	30 mL
Washing buffer	170 mL
Elution buffer	60 mL
Vivaspin® 20, 100 kDa MWCO	2
Operating manual	1 each for Kit and Vivaspin®

Technical data

Kit specifications

Sample size	1000 mL cell culture
Number of purifications	1 × 1000 mL
Infective particles (IP) per mL	Typically up to $4-5 \times 10^9$ *
Processing time	Typically up to 6 hours
Endotoxin level	< 0.025 EU/mL

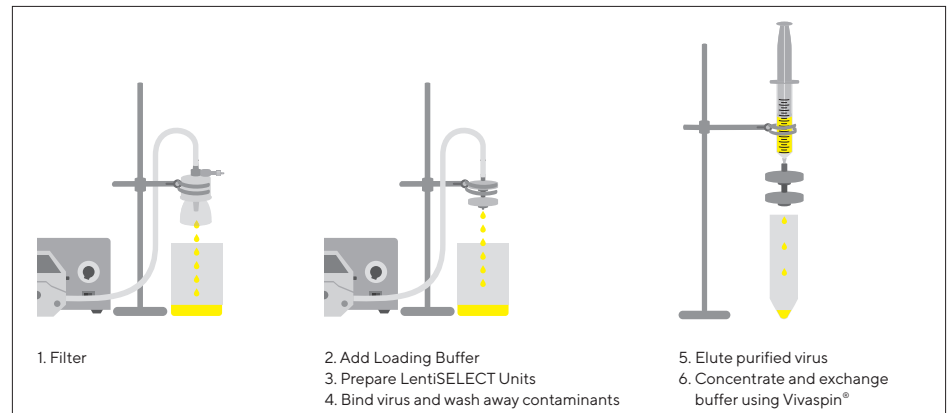

* 2 mL final elution sample



Application Notes

Table of Contents

1. Desalting and Buffer Exchange with Vivaspin® Centrifugal Concentrators	74
2. Treatment of Vivaspin® Concentrators for Improved Recovery of Low-concentrated Protein Samples	77
3. Scouting Protein Purification Conditions Using Vivapure® Centrifugal Ion Exchange Membrane Absorbers	80
4. Sartorius Ultrafiltration Products for the Concentration and Purification of Viruses – a Short Review	85
5. Sartorius Ultrafiltration Products in the Preparation of Biological Nanoparticles and Medical Nanocarriers	91

1. Desalting and Buffer Exchange with Vivaspin® Centrifugal Concentrators

Introduction

Vivaspin® centrifugal concentrators, with patented vertical membrane technology, combine fast filtration with high recovery of target proteins. This makes Vivaspin® the technology of choice for desalting or buffer exchange, avoiding lengthy dialysis steps.

While proteins are retained by an appropriate ultrafiltration membrane, salts can pass freely through, independent of protein concentration or membrane MWCO. In consequence, the composition of the buffer in the flow-through and retentate is unchanged after protein concentration. By diluting the concentrate back to the original volume, the salt concentration is lowered. The concentrate can be diluted with water or salt-free buffer if simple desalting is required; however, it is also possible to dilute the concentrate with a new buffer, thereby exchanging the buffering substance entirely. For example, a 10 mL protein sample containing 500 mM salt, if concentrated 100× still contains 500 mM salt. If this concentrate is then diluted 100× with water or salt-free buffer, the protein concentration returns to normal, while the salt concentration is reduced 100x to only 5 mM, (I.E. a 99% reduction in salt).

The protein sample can then be concentrated again to the desired level, or the buffer exchange can be repeated to reduce the salt concentration even further before a final concentration of the protein. This process is called 'diafiltration'. For proteins with a tendency to precipitate at higher concentrations, it is possible to perform several diafiltration steps in sequence, with the protein concentrated each time to only 5 or 10x. For example, if a precipitous protein sample is concentrated to 5x then diluted back to the original volume, and this process is repeated a further two times, this still results in a >99% reduction in salt concentration, without over concentrating the protein.

Desalting and buffer exchange procedure (see figure 1.)

1. Select the most appropriate MWCO for your sample. For maximum recovery, select a MWCO $\frac{1}{2}$ to $\frac{1}{3}$ the molecular size of the species of interest.
2. Fill concentrator with up to the maximum volume stated in the device operating instructions*, (e.g. 20 mL if Vivaspin® 20 is used).
3. If the sample is smaller than the maximum device volume*, it can be diluted up to the maximum volume before the first centrifugation step. This will help increase the salt removal rate.
4. Centrifuge for the recommended amount of time at an appropriate spin speed for your Vivaspin® model*.
5. Empty filtrate container**.
6. Refill concentrator with an appropriate solvent.
7. Centrifuge again as before.
8. Empty filtrate container†.
9. Recover the concentrated, de-salted sample from the bottom of the concentrate pocket with a pipette.

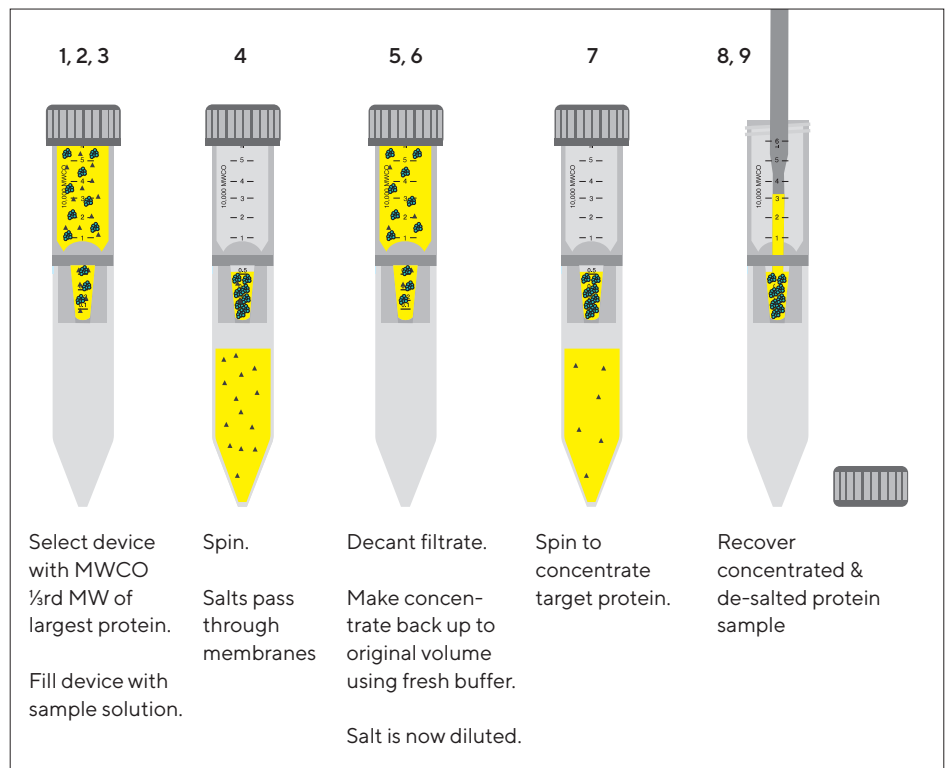

Figure 1: Step-by-step method for desalting and concentration

Notes

- * For guidance on maximum fill volumes, spin speeds and suggested spin times, please refer to the Operating Instructions that accompany your Vivaspin® products.
- ** Filtrate volumes should be retained until the concentrated sample has been analyzed.

Test results

As the results below show, the efficient design of Vivaspin® devices allowed >95% of the salt to be removed during the first centrifugation step. Only one

subsequent centrifugation step was needed to increase the typical salt removal to 99% with >92% recovery of the sample.

Vivaspin® 20

MWCO	5 kDa		30 kDa		50 kDa		100 kDa	
	Cytochrome C 0.25 mg/mL		BSA 1 mg/mL		BSA 1 mg/mL		IgG 1 mg/mL	
	Protein Recovery	NaCL Removal	Protein Recovery	NaCL Removal	Protein Recovery	NaCL Removal	Protein Recovery	NaCL Removal
Spin 1	100%	99%	97%	99%	97%	99%	90%	98%
Spin 2	96%	100%	92%	100%	93%	100%	87%	100%

Four Vivaspin® 20 devices of each cut-off were tested with 20 mL of solution. Each of the solutions contained 500 mM NaCl. Each spin was performed at 4,000 × g. The devices > 5 kDa were spun for 30 min. The devices with 5 kDa were spun 45 min. After the first and second spin, the

retentate was brought up to 20 mL with ultra pure water from the Arium® system (Sartorius). OD readings were taken at 410 nm for the Cytochrome C and 280 nm for the BSA and IgG samples. Salt concentration was measured with a Qcond 2200 conductivity measuring instrument.

Vivaspin® 6

MWCO	5 kDa		30 kDa		50 kDa		100 kDa	
	Cytochrome C 0.25 mg/mL		BSA 1 mg/mL		BSA 1 mg/mL		IgG 1 mg/mL	
	Protein Recovery	NaCL Removal	Protein Recovery	NaCL Removal	Protein Recovery	NaCL Removal	Protein Recovery	NaCL Removal
Spin 1	98%	99%	92%	99%	93%	99%	92%	98%
Spin 2	85%	100%	86%	100%	83%	100%	89%	100%

Four Vivaspin® 6 devices of each cut-off were tested with 6 mL of solution. Each of the solutions contained 500 mM NaCl. Each spin was performed at 4,000 × g. The devices > 5 kDa were spun for 30 min. The devices with 5 kDa were spun 45 min. After the first and the second spin the

retentate was brought up to 6 mL with ultra pure water from the Arium® system (Sartorius) OD readings were taken at 410 nm for the Cytochrome C and 280 nm for the BSA and IgG samples. Salt concentration was measured with a Qcond 2200 conductivity measuring instrument.

2. Treatment of Vivaspin® Concentrators for Improved Recovery of Low-concentrated Protein Samples

Introduction

With appropriate device size and membrane cut-off selected, Vivaspin® products will typically yield recoveries for the concentrated sample > 90% when the starting sample contains over 0.1 mg/mL protein of interest. Depending on sample characteristics relative to the membrane type used, solute (protein) adsorption on the membrane surface is typically very low (2–10 µg/cm²) and in practice not detectable.

This can increase to 20–100 µg/cm² when the filtrate is of interest and the sample must pass through the whole internal structure of the membrane. Whilst the relative adsorption to the plastic of the sample container will be proportionately less important than on the membrane, due to the higher total surface area, this can be also be a source of yield loss. Typically, a higher cut-off membrane will bind more than a low molecular weight alternative.

Whenever possible, the smallest MWCO and device size applicable should be chosen. Swinging bucket rotors are preferred to fixed angle rotors. This reduces the surface area of the concentrator that will be exposed to the solution during centrifugation.

An important factor not to be neglected is the thorough recovery of the retentate. Make sure to carefully remove all traces of solution from the sample container and, if feasible, rinse the device after recovering the sample with one or more drops of buffer and then recover again.

The intention of the following “passivation” procedure is to improve recovery of protein samples in the nano- to microgram concentration range by pretreating the device (membrane & plastic). For this purpose a range of solutions are suggested in Table 1.

Table 1: Passivation Solutions

Type	Concentration
Powdered milk	1% in Arium® water
BSA	1% in PBS
Tween 20	5% in Arium® water
SDS	5% in Arium® water
Triton X-100	5% in Arium® water
PEG 3000	5% in Arium® water

Passivation procedure for Vivaspin® ultrafiltration concentrators

A) Passivation procedure

1. Wash the concentrators once by filling with Arium® water and spin the liquid through according to the respective protocol.
2. Remove residual water thoroughly by pipetting.
Caution: Take care not to damage the membrane with the pipette tip.
3. Fill concentrators with the blocking solution of choice as given in Table 1.
4. Incubate the filled concentrators at room temperature for at least 2 hours (overnight is also possible except for Triton X-100 which is not recommended for overnight incubation).
5. Pour out the blocking solution.
6. Rinse the device 3–4 × very thoroughly with Arium® water and finally spin through.
7. The “passivated” devices are now ready for use. We recommend comparing different passivation reagents with an untreated device.

Note

It is necessary to rinse the device thoroughly before each washspin to ensure that traces of passivation compound are removed from the deadstop. Use the device immediately for protein concentration or store it at 4°C filled with Arium® water, to prevent the membrane from drying.

B) Evaluation of passivation effects (exemplary with BSA)

1. Prepare a 10 µg/mL BSA stock solution e.g. by diluting 90 µL of the 4 mg/mL stock solution in 36 mL 0.1 M sodium borate pH 9.3. Mix well.
2. Fill Vivaspin® 2 devices with 2 mL of this 10 µg/mL BSA solution and close with cap provided.
3. Spin the device in a swing-out rotor at 4,000 × g until the volume is to app. 100 µL.
4. Recover the concentrate and make back up to 2 mL with 0.1 M sodium borate pH 9.3
5. Determine recovered protein concentrations e.g. according to Bradford or BCA assays.

Results and discussion

As an example, the effect of milk powder was analysed. It could be shown (Table 2) that the protein recovery of a 10 µg/mL BSA solution could be increased from around 70 to 90%. If milk powder is not interfering with sample purity and quality, it is a good starting point to improve recovery of diluted sample solutions.

Protein recovery (10 µg/mL BSA) with Vivaspin® PES 10 kDa after passivation

In another example, detergents were analysed with only 250 and 500 ng BSA (Table 3). BSA recovery declined to 50-30% in untreated devices as the protein concentration was reduced. Significant improvement to 60-90% recovery could be demonstrated when using the passivation strategy. Often, Triton X-100 seemed to work though the optimal reagent has to be selected for the respective protein and its hydrophilic|phobic characteristics.

Summary

Passivation is an appropriate method to achieve increasing sample recovery when using very dilute samples. In addition to skimmed milk, other proteins (BSA), detergents and compounds are possible. However, it should be noted that this is a general procedure, not specific for any particular application. Depending on the hydrophilic | -phobic character of the protein non-specific binding may be more or less of a problem and the suggested passivation solutions may lead to different results. Even with the Hydrosart® membrane, which is recommended

for dilute samples, passivation of the device will reduce losses on the plastic surface. One very important thing to remember is that the blocking agent is potentially introduced into the sample. It should be assured that this will not interfere with downstream analysis. For example, proteins must not be used for passivation if a pure protein is intended to be concentrated for x-ray crystallography, as even the smallest traces would interfere with the diffraction pattern. Other subsequent analyses methods include activity testing, gel electrophoresis or labelling are less problematic.

Table 2: Protein recovery (10 µg/mL BSA) with Vivaspin® PES 10 kDa after passivation

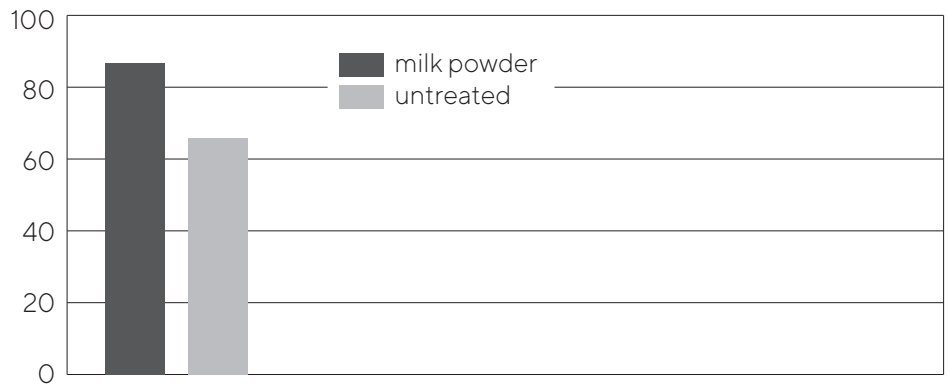
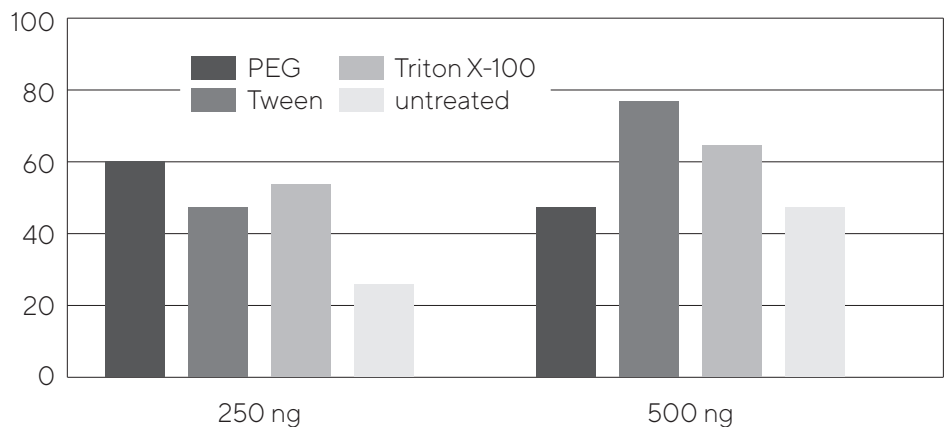

Table 3: Protein recovery (250 and 500 ng BSA) with Vivaspin® 2 PES 10 kDa after passivation



3. Scouting Protein Purification Conditions Using Vivapure® Centrifugal Ion Exchange Membrane Absorbers

Introduction

For separation and purification of proteins from biological samples, different characteristics of the target protein e.g. its size, charge, hydrophobicity or specifically engineered tags are exploited.

With ion exchange chromatography, separation is achieved on the basis of different charges of biomolecules. This makes it to a versatile method often used for pre-fractionation or purification of a target protein from crude protein mixtures. To optimize the purification procedure for an individual target, several binding and elution conditions have to be tested on cation and anion exchange matrices.

In contrast to traditional column chromatography methods, Vivapure® IEX centrifugal columns allow scouting of several chromatography conditions in parallel, leading quickly to different fractions which can be further analyzed for enriched or even already purified target protein.

Here, we demonstrate the performance of Vivapure® IEX Mini spin columns for evaluation of optimal purification conditions of cloned SH2 domains from an *E. coli* lysate in a two step procedure. This protocol can generally be employed for finding a purification method based on ion exchange chromatography for a given target protein as it is fast and only uses up small amounts of the sample.

In the first step of this protocol, binding conditions are evaluated by loading the sample on Vivapure® Q and S columns at various pH-values, eluting bound proteins with a high salt concentration buffer and analyzing all fractions for the target protein. This

step results in the optimal binding pH and the best ion exchange chemistry for the purification.

In a second step, the best elution method is evaluated by applying increasing salt concentrations to columns which were shown to bind the target protein in step one, leading to a complete purification protocol in less than one hour.

Experiment

Using the described scouting procedure, a purification method for a SH2 domain expressed in *E. coli* was developed. In a first step, proteins were bound to the Vivapure® IEX membranes at different pH values, then eluted with high-salt buffer. In Step Two a fresh sample was adjusted to the respective pH elucidated previously as the best choice for binding the protein and was loaded onto a new column for refining optimal elution conditions.

Materials

- Vivapure® Mini Q H spin columns
- Vivapure® Mini S H spin columns
- Minisart® syringe filter (0.45 µm CA, Sartorius Stedim Biotech GmbH)
- Centrifuge, 45°-fixed-angle rotor; 2000 × g

Buffers used

Buffer A:	25 mM Citrate, pH 4
Buffer B:	25 mM Potassiumphosphate, pH 6
Buffer C:	25 mM HEPES, pH 8
Buffer D:	25 mM Sodiumbicarbonate, pH 10
Buffer E:	25 mM Citrate, pH 4, supplemented with 1 M NaCl.
Buffer F:	25 mM Potassiumphosphate, pH 6, supplemented with 0.2 M, 0.4 mM, 0.6 mM, 0.8 mM, & 1 M NaCl, respectively.
Buffer G:	25 mM HEPES, pH 8, supplemented with 1 M NaCl
Buffer H:	25 mM Sodiumbicarbonate, pH 10, supplemented with 1 M NaCl

Procedure

Step One: Scouting for binding conditions to the appropriate ion exchange chemistry.

Expression of target protein

300 mL LB media were inoculated with 4 mL of an overnight culture and incubated at 37°C, shaking at 150 rpm until an OD₆₀₀ of 1.0 was reached. IPTG was added to a final concentration of 1 mM and incubated for further 4 h with shaking at 150 rpm. Cells were harvested by centrifugation at 4000 × g for 30 min at 4°C. The pellet was resuspended in 35 mL PBS (150 mM KPi, pH 7,3) and cells were lysed by addition of lysozyme to a final concentration of 0.1 mg/mL and incubation for 1 h at 37°C. Insoluble particles as cell debris were removed by centrifugation at 10000 × g for 30 min at 4°C.

Sample preparation

4 × 200 µL of the cell lysate were diluted with 1.8 mL binding buffer A to D each, to adjust the sample to the respective pH conditions. In order to avoid clogging of the membranes in the Vivapure® Mini spin columns, samples were clarified by passage through Minisart® syringe filters.

Column equilibration

4 × Q and 4 × S Vivapure® Mini spin columns were labeled 4, 6, 8 and 10 corresponding to the pH of the buffer to be used. To each spin column, 400 µL of the corresponding binding buffer were added and spun for 5 minutes at 2000 × g.

Binding and washing

400 µL of the clarified samples adjusted to pH values 4, 6, 8 and 10 were applied each to the correspondingly equilibrated Vivapure® Q and S spin columns. Columns were spun for 5 min at 2000 × g. Afterwards, Vivapure® Mini spin columns were reloaded with 400 µL sample and spun again for 5 min at 2000 × g. Loosely bound proteins were washed away with the application of 400 µL of the respective binding buffer to each of the columns and spinning for 5 min at 2000 × g. Flow-through and wash fractions were collected for subsequent detection of the target protein.

Complete elution of bound proteins

200 µL of elution buffer E, F, G and H, were applied to the washed columns and spun for 3 min at 2000 × g. Eluates were saved for subsequent analysis.

Analysis

4 µL of flow-through, wash, and elution fractions from each column were analyzed on reducing SDS-PAGE followed by silver staining.

Result of Step One

Dilution of the *E. coli* lysate with binding buffer A (25 mM Citrate, pH 4) lead to complete precipitation of sample proteins. Thus, pH 4 could not be tested in this experiment. As can be seen on the SDS gel in figure 1, the target protein was present in the eluate of the Vivapure® Q Mini spin column at all pH values tested together with most of the *E. coli* proteins (Lanes Q “e”). In contrast, using the Vivapure® S Mini spin column, at all pH-values tested, most *E. coli* proteins did not bind to the membrane and were found in the flow-through (Lane Lane S “f”), thus resulting in pure target protein in all elution fractions (Lane S “e”).

Differences could be detected in the binding efficiency of the target protein as at pH 8 traces of the target protein were already found in the flow-

through, with slightly higher amounts at pH 10 (Lane S “e”). At pH 6, the most efficient binding of the target protein to the S membrane was observed.

Now that the binding conditions, i. e. binding pH and the best suited ion exchange chemistry, were found, the elution protocol of the target protein was optimized in a second step.

Step Two: Optimizing elution conditions

Sample preparation

Taking account of the results of Step One, 200 µL cell lysate were diluted with 1.8 mL binding buffer B (25 mM KPi, pH 6). In order to avoid clogging of the membrane in the Vivapure® Mini spin column, the pH adjusted sample was clarified by passage through a Minisart® syringe filter.

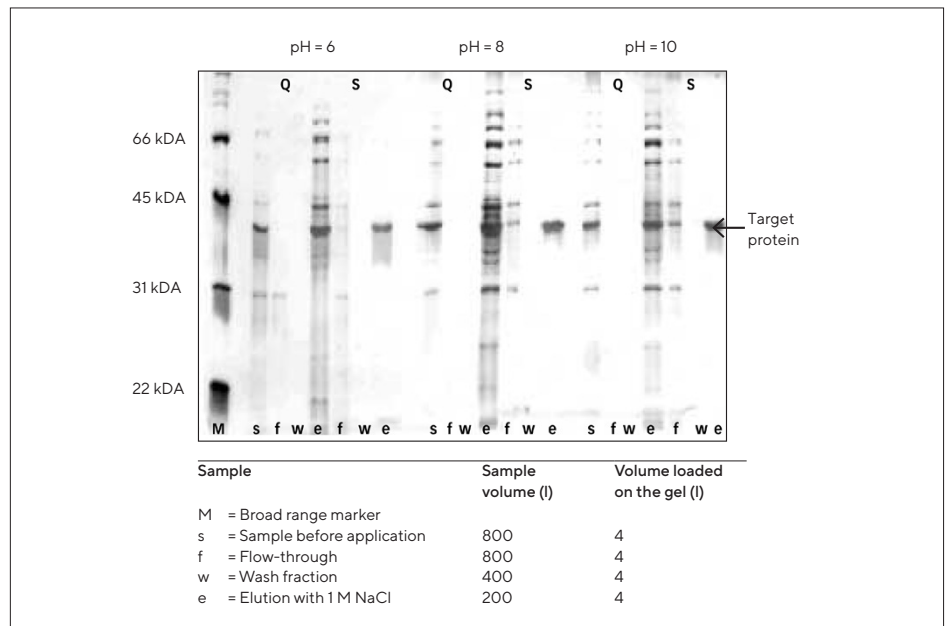

Fig. 1: Scouting for optimal binding conditions of a SH2 domain expressed in *E. coli*. SDS gel (reducing, 12%), silver stained. Shown are sample before loading, flow-through, wash, and elution fractions (1 M NaCl) from Vivapure® Q and S Mini spin columns, at the various pH values tested.

Column equilibration

400 μ L binding buffer B were applied to one Vivapure[®] S Mini spin column and spun for 5 minutes at 2000 \times g. Binding and washing 400 μ L of the clarified sample were applied to the equilibrated Vivapure[®] S column and spun for 5 min at 2000 \times g. Afterwards, the Vivapure[®] S Mini spin column was reloaded with 400 μ L sample and spun again for 5 min at 2000 \times g. Loosely bound proteins were washed away by application of 400 μ L binding buffer to the column and spinning for 5 min at 2000 \times g. Flow-through and wash fraction were saved for analysis.

Stepwise elution

100 μ L elution buffer F, supplemented with 0.2 M NaCl were applied to the Vivapure[®] S Mini spin column and spun for 3 min at 2000 \times g. The eluate

was collected. In the next step, 100 μ L of elution buffer F, supplemented with 0.4 M salt were applied and again spun for 3 min at 2000 \times g. Elution was continued until the entire gradient had been tested, saving the eluates from each step.

Analysis

4 μ L of flow-through, wash, and elution fractions from each column were analyzed on reducing SDS-PAGE followed by silver staining.

Result of Step Two

The target protein started to elute with 200 mM NaCl, however the main fraction eluted with 400 mM NaCl. Traces of the target protein were also found in the next elution step with 600 mM NaCl, but this might be due to the low elution volume.

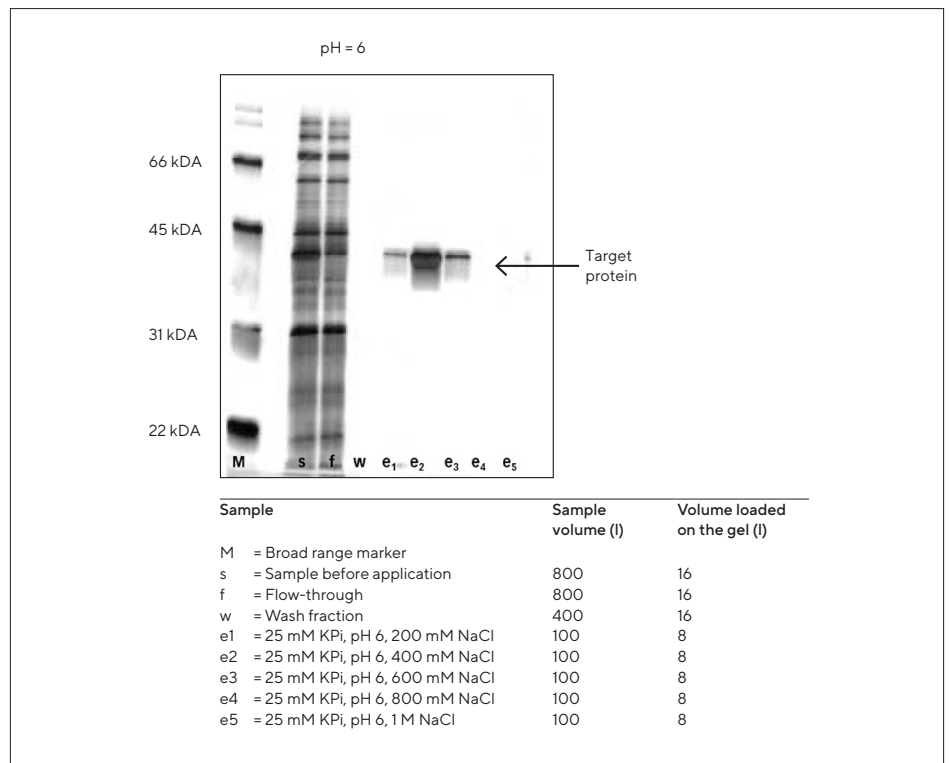

Fig. 2 Scouting for optimal elution conditions of a SH2 domain expressed in *E. coli*. SDS gel (reducing, 12%), silver stained. Sample before loading, flow-through, wash, and elution fractions from Vivapure[®] S Mini spin column at pH 6 are shown.

Discussion

A two-step procedure was used to rapidly scout optimal purification conditions for a target protein (a SH2 domain from *E. coli* lysate) with ion exchange chromatography. In the first step, the most suited buffer pH for binding the target protein to the most adequate ion exchanger was verified. In the second step, the elution condition was optimized building on the results gained in step one of this protocol (elution optimization after optimal binding of the target to the proper ion exchanger). With the scouting procedure described here, it was possible to quickly and conveniently purify the target protein to homogeneity.

The results obtained in this experiment can be used for various ends, e.g:

- polishing a specific protein after a first chromatography step with another chemistry
- establishing quickly a FPLC method for a new protein
- finding a purification method for a new protein for upscaling with Vivapure® Maxi or Mega.

For these purposes Vivawell 96well plates, Vivapure® Maxi and Mega columns and Sartobind® membrane adsorber units with FPLC connectors are available.

4. Sartorius Ultrafiltration Products for the Concentration and Purification of Viruses – a Short Review

Introduction

Evolutionary, viruses developed various different mechanisms to interact and manipulate the genetic material of their target cells. Based on this, modern molecular biology utilizes viruses in a constantly growing number of applications.¹ They range from controlled genetic transfection of cells to a variety of different basic studies in medical science.² In medical studies the strategic focus is on recombinant vaccines and on the development of potential vectors for gene therapy.^{3,4}

Besides the great relevance of viruses for medical applications, the assessment of virus type and content is important for the risk assessment of food and drinking water.⁵ Also, the classification of virus content is often of high relevance for the quality control of aquatic biotopes.⁶

During the preparation, handling, or analysis of viruses or virus-like particles (VLPs), a concentration and/or purification step is frequently required.⁵ Typical viruses have a size within the range of about 20 nm up to several hundred nanometers.⁷ Therefore they are ideally suited for the retention on ultrafiltration membrane systems and such ultrafilters are widely used in basic virus research. The specifications of such ultrafiltration devices depend on the particular type of virus and the purpose of the subsequent application.

This short review highlights methods for the purification of various mammalian viruses for basic medical research. Also, the concentration of pathogenic viruses from water and food samples and the purification of marine bacteriophages (virioplankton) are highlighted. It will also give guidance for the selection of an ideal performing device with the optimum molecular weight cut-off (MWCO) for the user specified ultrafiltration process.

Concentration of mammalian viruses in medical research

In medical research viruses and VLPs are of major interest, particularly for investigations on infectious viral diseases and for the development of vaccines or antiviral drugs. Moreover, certain VLPs can manipulate genetic material in a directed manner and are used broadly in the development of genetic therapy approaches. Additionally, viral vectors are well established as a transfection method for gene transfer to cell lines e. g. to manipulate mammalian cells *in vivo* and *in vitro*.

An overview of thematically linked publications using Sartorius ultrafiltration devices for the purification and concentration of viruses and VLPs in the medical context is given in Table 1. Among other applications, Vivaspin® devices were employed for the concentration of adeno-associated virus (AAV) and lentiviral vectors after purification via ion exchange chromatography,⁸⁻¹⁰ on blood sera to prepare blank samples from hepatitis C virus (HCV)-positive blood sera,¹¹ for the development of a vaccine against human immunodeficiency virus (HIV) and of an antiviral drug against Chikungunya virus.^{12,13}

Table 1: Summarized examples of applications with Vivaspin® and Vivaflow® for of viruses in medical reserch

Goal of Research (Type of virus, Host Organism)	Purpose of Filtration (Buffer System)	Sartorius Ultra- filtration Device (MWCO)	Subsequent Step	Ref.
Gene therapy (Adenovirus type 5, VLP, human)	Diafiltration (20 mM Tris saline buffer)	Vivaflow® (100 kDa)	Storage, chromatography on Sartobind® STIC membrane absorber (FPLC)	14
Reduction of HCV- induced fibrosis (Hepatitis C Virus; human)	Removal of HCV from human blood serum (Blood serum)	Vivaspin® (30 kDa)	Preparation of negative control (from positive sample) for immuno- fluorescence assay, fibrosis induction assays	11
Development of a viral entry inhibitor for HIV (HIV, human)	Removal of protein fraction from virus (PBS)	Vivaspin® 20 (1,000 kDa)	Virus inactivation	12
Gene therapy for cancer treatment (adeno-associated virus; rAAV-2, human)	Concentration and purification after expression, Buffer exchange after His tag (FreeStyle 293 Expression Medium (Gibco), serum-free)	Vivaspin® 20 (1,000 kDa)	Titer, ELISA, cell binding assay, apoptosis cell cycle assay	8
System for controlled gene expression in mice brain (Adeno- associated virus, mice)	Concentration of eluate after anion exchange chromatog- raphy (elution buffer)	Vivaspin® 20 (100 kDa)	Transduction of mice neurons	9
Efficient gene transfer into the CNS (Lentivirus, human)	Concentration after ion exchange chromatography (PBS)	Vivaspin® (100 kDa)	Quantification via real- time PCR and end-point dilution. Transduction of murine neuronal and glial cells <i>in vivo</i>	10
Identification of effective chikungunya antiviral drugs (Chikungunya-Virus, human)	Concentration	Vivaspin® 20 (100 kDa)	Quantification by TCID ₅₀	13
Gene therapy of achromatopsia in mice (Recombinant adeno-associated virus, human virus used in mice)	Concentration (Anion exchange chromatography elution buffer)	Vivaspin® 4 (10 kDa)	Titer determination by dot-blot analysis, subretinal injections	15

Concentration of viruses from drinking water and food samples

The guidelines for drinking-water quality by the world health organization describe safety plans to reduce potential risks from various virus infections.¹⁶ It states that, due to the increased resistance of viruses to disinfection methods, an absence of bacterial contamination after disinfection cannot be used as a reliable indicator of the presence | absence of pathogenic viral species in drinking water supplies. Considering this, ultrafiltration can play a vital role in detecting such viral contaminations for the research on drinking water quality and food safety.

For an ultrafiltration step, the water sample does not have to be pre-conditioned and its efficacy in concentrating the virus is virtually independent

of the chemical properties and the structure of the virus.¹⁷ Thus ultrafiltration is very well suited to isolate and concentrate virus particles from water samples and is a valuable aid during the assessment of water quality. Most of the viruses which are found in water and also food samples are of fecal origin. Screening for these viruses is crucial to prevent infections. The most frequent ones are hepatitis A, hepatitis E and norovirus.¹⁸ Ultrafiltration has been described as the most appropriate method for the recovery of hepatitis A virus from vegetables and other food items.¹⁹ Detection of infectious viruses is mainly done by propagation in cell culture (plaque assay) or the detection of the viral genomes by molecular amplification techniques such as quantitative reverse transcriptase polymerase chain reaction (RT-PCR).²⁰

Table 2: Summarized examples of ultrafiltration application with Vivaspin® and Vivaflow® with viruses from drinking water and food samples

Goal of Research (Type of virus, Host Organism)	Purpose of Filtration (Buffer System)	Sartorius Ultrafiltration Device (MWCO)	Subsequent Step	Ref.
Method for the detection of norovirus genogroup I (Norovirus, human)	Concentration (PBS processed food samples)	Vivaspin® (5 kDa)	RNA extraction for real-time RT-PCR	22
Analysis of viral content in groundwater (A set of pathogenic viruses, potentially human)	Concentration of drinking water sample (Drinking water)	Vivaflow® 200 (10 kDa)	Qualitative analysis (enterovirus) by RT-nested PCR and microtiter neutralization test	21
Comparative Analysis of Viral Concentration Methods (Hepatitis A virus, human)	Concentration (0.25 M threonine, 0.3 M NaCl, pH 9.5)	Vivaspin® 20 (100 kDa)	RNA extraction for real-time RT-PCR	19
Analysis of regional outbreak of gastroenteritis due to drinking water contamination (Norovirus, Astrovirus, Rotavirus, Enterovirus, Hepatitis A virus; human)	Concentration (50 mmol/L glycine buffer, 1% beef extract)	Vivaspin® 2	Nucleic acid extraction	23

Concentration of viruses and bacteriophages from marine biological samples

In marine biology, the concentration and subsequent analysis of marine bacteriophages (virioplankton) is of major interest. They outnumber the bacterioplankton (their host organisms) by an order of magnitude and thus have an important influence on the whole marine biosphere.²⁴

As described by Wyn-Jones & Sellwood (ref. 17) ultrafiltration can be used to concentrate virus particles in water samples without any prior pretreatment of the sample and it is also practically independent from the

chemical and structural properties of the viruses. Thus, it finds wide use for the analysis of aquatic viruses. For instance, Schroeder et al. (ref. 26) were able to determine the diversity and monitor population dynamics of viruses that infect *Emiliana huxleyi*, a globally important form of photosynthetic plankton. In this study a reusable Vivaflow[®] 50 unit equipped with a polyethersulfone (PES) membrane with MWCO of 50 kDa was used to concentrate viruses in sea water samples prior to storage and analysis. For further examples of virus concentration from marine biological samples see table 3.

Table 3: Summarized examples of ultrafiltration applications with Sartorius Vivaflow[®] and Vivaspin[®] of samples from marine biology

Goal of Research (Type of virus, Host Organism)	Purpose of Filtration (Buffer System)	Sartorius Ultra-filtration Device (MWCO)	Subsequent Step	Ref.
Assessment of virioplankton diversity (Virioplankton, Plankton)	0.2 µm filtration for clarification, filtrate subjected to 3 kDa filter for concentration (Sea water)	Vivaflow [®] 200 (0.2 µm and 30 kDa)	Subsequent analysis by DNA separation on Agarose gel	25
Classification of virus (MpRNAV-01B, <i>Micromonas pusilla</i>)	Vivaflow [®] 200: harvest and concentration of whole cell lysate; Vivaspin [®] : washing (removal of CsCl)	Vivaflow [®] 200, Vivaspin [®] (30 kDa)	Classification of new virus: genome, proteins, stability, etc.	28
Assessment of genetic diversity in virioplankton (<i>Emiliana huxleyi</i> Bloom virus, Eukaryotic phytoplankton - alga)	After 0.45 µm filtration, concentration 1 L to 20 mL (Sea water)	Vivaflow [®] 50 (50 kDa)	PCR and Denaturing gradient gel electrophoresis	26
Investigation of gene expression during infection (<i>Emiliana huxleyi</i> virus strain 86, Eukaryotic phytoplankton - alga)	Concentration from 5 L to 20 mL (f/2 medium)	Vivaflow [®] 50 (50 kDa)	CsCl-gradient	27
Study on host genome integration (<i>virophage mavirus</i> , <i>Cafeteria roenbergensis</i>)	Clarification with 0.2 µm filter and concentration with 100 kDa filter (<i>Cafeteria roenbergensis</i> , f/2 medium)	Vivaflow [®] 200 (0.2 µm and 100 kDa)	CsCl gradients, electron microscopy	29

Conclusion

As mentioned before, the purification of virus by ultrafiltration is virtually independent of the chemical properties and the structure of the virus particles. As viruses have a size within the range of about 20 nm up to several hundred nanometers, they are typically several orders of magnitude bigger than even the biggest protein complexes.⁷ Therefore, most viruses are unfailingly retained on membranes with large MWCOs of up to 1,000 kDa. The exact specifications of the ideal ultrafiltration membranes depend on the purpose of the subsequent application.

During the preparation of viral vectors for medical studies, a buffer exchange after column purification can be performed with various MWCOs of all sizes.^{8,9,10,15} To separate virus particles from small proteins, a 1,000 kDa cut off has been shown to work.¹² For the complete removal of HCV from blood serum a 30 kDa MWCO has been utilized.¹¹ When the assessment of whole virus content is crucial (e.g. food, drinking water or marine water samples) smaller MWCOs (5 – 100 kDa) are used to ensure full recovery of virus particles.^{19,21,22,25-29}

Abbreviations

AAV	Adeno-associated virus
CNS	Central nervous system
DNA	Deoxyribonucleic acid
ELISA	Enzyme-linked immunosorbent assay
FPLC	Fast protein liquid chromatography
HCV	Hepatitis C virus
HIV	Human immunodeficiency virus
kDa	Kilodalton (1000 g per mole)
M	Molarity (mole per litre)
mol	Mole
MWCO	Molecular weight cut-off
PBS	Phosphate buffered saline
PCR	Polymerase chain reaction
PES	Polyethersulfone
RNA	Ribonucleic acid
RT-PCR	Reverse transcriptase-polymerase chain reaction
TCID50	50% Tissue culture Infective Dose
VLP	Virus-like particle

References

1. Vannucci, L., Lai, M., Chiuppesi, F., Ceccherini-nelli, L. & Pistello, M. Viral vectors : a look back and ahead on gene transfer technology. *New Microb.* 36, 1-22 (2013).
2. Luo, D. & Saltzman, W. M. Synthetic DNA delivery systems. *Nat. Biotechnol.* 8, 33-37 (2000).
3. Ura, T., Okuda, K. & Shimada, M. Developments in Viral Vector-Based Vaccines. *Vaccines* 2, 624-41 (2014).
4. Mingozi, F. & High, K. A. Therapeutic in vivo gene transfer for genetic disease using AAV: progress and challenges. *Nat Rev Genet* 12, 341-355 (2011).
5. Soule, H., Genoulaz, O., Gratacap-Cavallier, B. Chevallier, P., Liu, J.-X. & Seigneurin, J.-M. Ultrafiltration and reverse transcription-polymerase chain reaction: an efficient process for poliovirus, rotavirus and hepatitis A virus detection in water. *Water Res.* 34, 1063-1067 (2000).
6. Bergh, O., BOrsheim, K. Y., Bratbak, G. & Heldal, M. High abundance of viruses found in aquatic environments. *Nature* 340, 467-468 (1989).
7. Hulo, C. et al. ViralZone: A knowledge resource to understand virus diversity. *Nucleic Acids Res.* 39, 576-582 (2011).
8. Hagen, S. et al. Modular adeno-associated virus (rAAV) vectors used for cellular virus-directed enzyme prodrug therapy. *Sci. Rep.* 4, 3759 (2014).
9. Schindler, S. E. et al. Photo-activatable Cre recombinase regulates gene expression in vivo. *Sci. Rep.* 5, 13627 (2015).
10. Scherr, M. et al. Efficient gene transfer into the CNS by lentiviral vectors purified by anion exchange chromatography. *Gene Ther.* 9, 1708-1714 (2002).
11. Granato, M. et al. HCV derived from sera of HCV-infected patients induces pro-fibrotic effects in human primary fibroblasts by activating GLI2. *Sci. Rep.* 6, 30649 (2016).
12. Martin, L. et al. Rational design of a CD4 mimic that inhibits HIV-1 entry and exposes cryptic neutralization epitopes. *Nat. Biotechnol.* 21, 71-76 (2003).
13. Karlas, A. et al. A human genome-wide loss-of-function screen identifies effective chikungunya antiviral drugs. *Nat. Commun.* 7, 11320 (2016).
14. Nestola, P. et al. Rational development of two flowthrough purification strategies for adenovirus type 5 and retro virus-like particles. *J. Chromatogr. A* 1426, 91-101 (2015).
15. Carvalho, L. S. et al. Long-term and age-dependent restoration of visual function in a mouse model of CNGB3-associated achromatopsia following gene therapy. *Hum. Mol. Genet.* 20, 3161-3175 (2011).
16. Guidelines for drinking-water quality - 4th ed. World Health Organization 2011.
17. Wyn-Jones, a P. & Sellwood, J. Enteric viruses in the aquatic environment. *J. Appl. Microbiol.* 91, 945-962 (2001).
18. Botzenhart, K. Viren im Trinkwasser. *Bundesgesundheitsblatt - Gesundheitsforsch. - Gesundheitsschutz* 50, 296-301 (2007).
19. Lee, K. B., Lee, H., Ha, S. D., Cheon, D. S. & Choi, C. Comparative analysis of viral concentration methods for detecting the HAV genome using real-time RT-PCR amplification. *Food Env. Virol.* 4, 68-72 (2012).
20. Bosch, A. et al. Analytical Methods for Virus Detection in Water and Food. *Food Anal. Methods* 4, 4-12 (2011).
21. Masciopinto, C. et al. Unsafe tap water in households supplied from groundwater in the Salento Region of Southern Italy. *J. Water Health* 5, 129-148 (2007).
22. Dreier, J., Störmer, M., Mäde, D., Burkhardt, S. & Kleesiek, K. Enhanced reverse transcription-PCR assay for detection of norovirus genogroup I. *J. Clin. Microbiol.* 44, 2714-2720 (2006).
23. Maunula, L. et al. Enteric Viruses in a Large Waterborne Outbreak of Acute Gastroenteritis in Finland. *Food Environ. Virol.* 1, 31-36 (2009).
24. Wommack, K. E. & Colwell, R. R. Virioplankton: viruses in aquatic ecosystems. *Microbiol. Mol. Biol. Rev.* 64, 69-114 (2000).
25. Parada, V., Baudoux, A.-C., Sintes, E., Weinbauer, M. G. & Herndl, G. J. Dynamics and diversity of newly produced virioplankton in the North Sea. *ISME J.* 2, 924-936 (2008).
26. Schroeder, D. C., Oke, J., Hall, M., Malin, G. & Wilson, W. H. Virus Succession Observed during an *Emiliania huxleyi* Bloom Virus. *Appl. Environ. Microbiol.* 69, 2484-2490 (2003).
27. Allen, M. J. et al. Locus-Specific Gene Expression Pattern Suggests a Unique Propagation Strategy for a Giant Algal Virus. *J. Virol.* 80, 7699-7705 (2006).
28. Brussaard, C. P. D., Noordeloos, A. A. M., Sandaa, R. A., Heldal, M. & Bratbak, G. Discovery of a dsRNA virus infecting the marine photosynthetic protist *Micromonas pusilla*. *Virology* 319, 280-291 (2004).
29. Fischer, M. G. & Hackl, T. Host genome integration and giant virus-induced reactivation of the virophage mavirus. *Nature* 540, 288-291 (2016).

5. Sartorius Ultrafiltration Products in the Preparation of Biological Nanoparticles and Medical Nanocarriers



Introduction

Paul Ehrlich was inspired by the idea of the “magic bullet”^{*} when he for the first time described in theory toxic drugs assembled to so-called “Nanocarriers” in 1908.¹ Today, Nanocarriers have found multiple applications in modern medicine and biotechnology. A key application for these special nanomaterials is a targeted delivery of drugs where they act as transport modules (i. e. as nanoparticles, vesicles, or micelles) for the active ingredient.^{2,3,4,5} This is assumed to be more effective and less toxic to the (human) organism compared to traditionally administered drug substances.⁶ Besides drug delivery, various further fields using Nanocarriers evolved during the last decades; e. g. magnetic resonance imaging or stem cell gene therapy with metal-based nanoparticles,^{7,8} or optical imaging with quantum dots.⁹

Nanocarriers can be categorized by their starting material (i. e. metal-, lipid-, polymer-, and protein-based) and by their formation after preparation (i. e. vesicles, particles and micelles). In general, the preparation of a nanoparticle suspension or a vesicle dispersion in an aqueous medium consists of three steps: a) assembly of the Nanocarriers (for example by injections, film hydration, or reverse phase evaporation), b) purification (exemplary: chromatography, dialysis or ultrafiltration), and c) concentration like ultrafiltration or evaporation.

This short review provides examples of recent literature dealing with the preparation of Nanocarriers. Particular focus is laid on the concentration and purification steps which were performed via ultrafiltration with Sartorius Vivaspin[®] or Vivaflow[®] devices with different pore sizes (respectively molecular weight cut-off, MWCO).

The Vivaspin[®] portfolio spans a volume range from 0.5 mL to up to 20 mL, whereas the Vivaflow[®] system covers volumes from 0.05 liters to up to 5 liters. Thus, Sartorius offers an unrivaled wide range of processable sample volumes, membrane materials and MWCOs to meet the different requirements of their intended use. Challenges in this context are buffer exchange after synthesis, desalting and washing,^{10,11} exclusion of solubilized compounds,^{12,13,14} or aggregates.¹⁵

Purification is essential to obtain isotonic conditions for in vivo applications to prevent aggregation or agglomeration and to remove free toxic drugs, ligands, or other substrates potentially triggering side effects. Concentration steps are essential to adjust the amount of pharmaceutical active ingredient in the drug to achieve the anticipated therapeutic or diagnostic effect.

During purification, the separation of free substances (starting material) from the desired Nanocarriers via size-exclusion chromatography (SEC) leads to an unavoidable dilution and to the necessity of a subsequent concentration step. In contrast, diafiltration purifies without significant dilution but a concentration step can still be mandatory, if higher Nanocarrier concentrations are necessary. Both separation methods require a quite extensive costly and time-consuming manual handling. This drawback is overcome by the ultrafiltration utilized by centrifugation in Vivaspin[®] or with a peristaltic pump for the Vivaflow[®] System. This technique is less expensive and quickly performed with very little manual input. Noteworthy is that purification and concentration steps are performed simultaneously.¹⁶

After the Nanocarrier is purified the determination of drug loading (conjugation or encapsulation efficiency) is commonly performed. The conjugation or encapsulation efficiency is one of the reference values to describe and characterize Nanocarriers. Other important properties are the zeta potential and the size distribution determined via photon correlation spectroscopy (PCS), high-resolution transmission electron microscopy (HRTEM) imaging, or via dynamic light scattering (DLS).

Prior to performing these different characterizations a successful purification and concentration of the suspension or dispersion is essential.

In the following table you can find an overview of publications using ultrafiltration steps for the purification and concentration of different kinds of Nanocarriers. This table will also give you a guidance on which MWCOs to use.

Table 1 summarizes examples of Nanocarrier ultrafiltration applications with Sartorius Vivaspin® or Vivaflow®:

Nanocarrier: Nanoparticle, Vesicle, Micelle	Size distribution obtained via (HR)TEM or DLS, Z-Average via PCS and others-if reported	Application	Sartorius Ultrafiltration Device	MWCO	Ultrafiltration purpose	Ref.
Nanoparticles from metal, metal oxides and functionalized metals						
Iron oxides nanoparticles with cisplatin- bearing polymer coating	SD: 4.5 ± 0.9 nm via X-Ray-Diffraction Analysis	Magnetic resonance imaging	Vivaspin® 20	100 kDa	Purification and concentration step	7
Functionalized iron oxide nanoparticles	SD: 38 and 40 nm via DLS	Stem cell gene therapy and tracking	Vivaspin® 20	100 kDa	Washing step	8
Gold nanoparticles	SD: 0.8-10.4 nm via Atomic Force Microscopy	Antimicrobial activity	Vivaspin® 20	5 kDa	Purification step	17
Protein coated gold nanoparticles	SD: 15 and 80 nm via TEM	Drug delivery	Vivaspin® 6	10 kDa	Separation of Nanoparticles Dyes and Washing	18
Functionalized gold nanoparticles	Core-SD: 2 nm via TEM	Targeted imaging tool and antigen delivery	Vivaspin®	10 kDa	Purification step	19
Functionalized gadolinium-based nanoparticles	Z-Average: 1.1 ± 0.6 nm and 4-14 nm	Diagnostic and therapeutic application	Vivaspin®	5 kDa, 10 kDa	Purification and Concentration	20, 21
Functionalized nanocrystals	SD: 10 to 20 nm	Quantum dots for imaging	Vivaspin®	300 kDa and 50 kDa	Separation of quantum dots-antibody conjugates from starting material (prior to enumeration)	9

* In German "ZauberKugel", opera "Freischütz" by Carl Maria von Weber

Nanocarrier: Nanoparticle, Vesicle, Micelle	Size distribution obtained via (HR)TEM or DLS, Z-Average via PCS and others-if reported	Application	Sartorius Ultrafiltration Device	MWCO	Ultrafiltration purpose	Ref.
Nanoparticles from polymers, functionalized polymers and polymersomes						
Polymer based Nanoparticles		Drug delivery	Vivaspin®	30 kDa	Purification and Concentration	22
Curdlan coated polymer nanoparticles	Z-Average: 280–480 nm depending on the composition	Macrophage stimulant activity and drug delivery	Vivaspin® 20	3 kDa	Washing	23
Docetaxel-carboxymethylcellulose Polymer Nanoparticles	Z-Average: 118 ± 1.8 nm	Anti-cancer efficacy studies	Vivaspin®	10 kDa	Concentration step	24
Functionalized Polymersomes	Z-Average: 185 nm	Surface functionalization studies	Vivaspin® 20	10 kDa	Concentration step	3
Lipid Nanoparticles and Liposomes						
Liposomes and micelles	Z-Average: 100 nm for Liposomes and 15 nm for micelles	Ischemia-reperfusion injury	Vivaspin® 20	100 kDa	Concentration step	25
Extracellular vesicles (Exosomes and microvesicles)	Exosomes: 70–150 nm Microvesicles: 100–1000 nm	Paper provides a general protocol	Vivaflow® 50R	100 kDa	Diafiltration and Concentration	26
Bacterial outer membrane vesicles	SD: 124 nm via TRPS	Tunable resistive pulse sensing (TRPS) Analysis	Vivaflow® 200	100 kDa	Buffer exchange and concentration step	27
Bacterial outer membrane vesicles		Basic research	Vivaspin® 20 and 500	100 kDa	Buffer exchange and concentration step	28
Bacterial outer membrane vesicles	SD: 95 nm	Basic research	Vivaflow® 200	100 kDa	Buffer exchange and concentration step	29
Bacterial outer membrane vesicles	SD: 50–150 nm via TEM	Basic research	Vivaspin®	100 kDa	Buffer exchange and concentration step	30
Liposomes		Drug delivery	Vivaspin®	100 kDa	External buffer exchange	2
Urinary exosomes	size of exosomes <100 nm	Preparation of urinary exosomes	Vivaspin® 20 and 500	100 kDa	Concentration	31
Micelles						
Micelles		Drug delivery	Vivaspin®	30 kDa	Separation of free substrate and concentration step	4
Hydrophobic drug micelles based on polymers	SD via DLS: 39–165 nm depending on compound in use	Drug delivery	Vivaflow®		Removal surfactant	14
Protein Nanoparticles						
Protein Nanoparticles	SD: 20–40 nm via DLS	Drug carrier studies	Vivaspin® 500	3 kDa	Separation of the free from the encapsulated drug (Drug binding quantification by subsequent UV Vis analysis)	32

SD = Size distribution

References

1. Strebhardt, K. & Ullrich, A.: Paul Ehrlich's magic bullet concept: 100 years of progress. *Biochem. J.* 416, 473–480 (2008).
2. Jakoby, J., Beuschlein, F., Mentz, S., Hantel, C. & Süss, R.: Liposomal doxorubicin for active targeting: Surface modification of the nanocarrier evaluated in vitro and in vivo – challenges and prospects. *Oncotarget* 6, (2015).
3. Klermund, L., Poschenrieder, S. T. & Castiglione, K.: Simple surface functionalization of polymersomes using non-antibacterial peptide anchors. *J. Nanobiotechnology* 14, 48 (2016).
4. Mulder, W. J. M. et al.: Molecular imaging of macrophages in atherosclerotic plaques using bimodal PEG-micelles. *Magn. Reson. Med.* 58, 1164–1170 (2007).
5. Murthy, S. K.: Nanoparticles in modern medicine: state of the art and future challenges. *Int. J. Nanomedicine* 2, 129–41 (2007).
6. Voigt, R. & Fahr, A.: *Pharmazeutische Technologie für Studium und Beruf*. Deutscher Apotheker Verlag, 10th Edition (2010).
7. Unterweger, H. et al.: Development and characterization of magnetic iron oxide nanoparticles with a cisplatin-bearing polymer coating for targeted drug delivery. *Int J Nanomedicine* 9, 3659–3676 (2014).
8. Park, W. et al.: Multi-modal transfection agent based on monodisperse magnetic nanoparticles for stem cell gene delivery and tracking. *Biomaterials* 35, 7239–7247 (2014).
9. Chalmers, N. I. et al.: Use of quantum dot luminescent probes to achieve single-cell resolution of human oral bacteria in biofilms. *Appl. Environ. Microbiol.* 73, 630–636 (2007).
10. Hoffman, L. W., Andersson, G. G., Sharma, A., Clarke, S. R. & Voelcker, N. H.: New insights into the structure of PAMAM dendrimer/gold nanoparticle nanocomposites. *Langmuir* 27, 6759–6767 (2011).
11. Rademacher, T. & Williams, P.: Nanoparticle-peptide compositions. (2014).
12. Allard, E. & Larpent, C.: Core-shell type dually fluorescent polymer nanoparticles for ratiometric pH-sensing. *J. Polym. Sci. Part A Polym. Chem.* 46, 6206–6213 (2008).
13. Prach, M., Stone, V. & Proudfoot, L.: Zinc oxide nanoparticles and monocytes: Impact of size, charge and solubility on activation status. *Toxicol. Appl. Pharmacol.* 266, 19–26 (2013).
14. Zhang, Y. et al.: Therapeutic surfactant-stripped frozen micelles. *Nat Commun* 7, 11649 (2016).
15. Klasson, A. et al.: Positive MRI contrast enhancement in THP-1 cells with Gd₂O₃ nanoparticles. *Contrast Media Mol. Imaging* 3, 106–111 (2008).
16. Simonoska Crcarevska, M. et al.: Definition of formulation design space, in vitro bioactivity and in vivo biodistribution for hydrophilic drug loaded PLGA/PEO-PPO-PEO nanoparticles using OFAT experiments. *Eur. J. Pharm. Sci.* 49, 65–80 (2013).
17. Boda, S. K. et al.: Cytotoxicity of Ultrasmall Gold Nanoparticles on Planktonic and Biofilm Encapsulated Gram-Positive Staphylococci. *Small* 11, 3183–3193 (2015).
18. Schäßler, M. et al.: Blood protein coating of gold nanoparticles as potential tool for organ targeting. *Biomaterials* 35, 3455–3466 (2014).
19. Arosio, D. et al.: Effective targeting of DC-sign by α -fucosylamide functionalized gold nanoparticles. *Bioconjug. Chem.* 25, 2244–2251 (2014).
20. Miladi, I. et al.: Biodistribution of ultra small gadolinium-based nanoparticles as therapeutic agent: application to brain tumors. *J. Biomater. Appl.* 28, 385–94 (2013).
21. Faure, A. C. et al.: Control of the in vivo biodistribution of hybrid nanoparticles with different poly(ethylene glycol) coatings. *Small* 5, 2565–2575 (2009).
22. Benita, S., Debotton, N. & Goldstein, D.: Nanoparticles for Targeted Delivery of Active Agent. (2008).
23. Tukulula, M. et al.: Curdlan-conjugated PLGA nanoparticles possess macrophage stimulant activity and drug delivery capabilities. *Pharm. Res.* 32, 2713–2726 (2015).

24. Ernsting, M. J., Tang, W. L., MacCallum, N. W. & Li, S. D.: Preclinical pharmacokinetic, biodistribution, and anti-cancer efficacy studies of a docetaxel-carboxymethyl-cellulose nanoparticle in mouse models. *Biomaterials* 33, 1445-1454 (2012).
25. Geelen, T., Paulis, L. E., Coolen, B. F., Nicolay, K. & Strijkers, G. J.: Passive targeting of lipid-based nanoparticles to mouse cardiac ischemia-reperfusion injury. *Contrast Media Mol. Imaging* 8, 117-126 (2013).
26. Corso, G. et al. Reproducible and scalable purification of extracellular vesicles using combined bind-elute and size exclusion chromatography *Scientific Rep.* 7, 11561 (2017).
27. Bogomolny, E. et al.: Analysis of bacteria-derived outer membrane vesicles using tunable resistive pulse sensing. *Prog. Biomed. Opt. Imaging - Proc. SPIE* 9338, 4-9 (2015).
28. Blenkiron, C. et al.: Uropathogenic *Escherichia coli* releases extracellular vesicles that are associated with RNA. *PLoS One* 11, 1-16 (2016).
29. Twu, O. et al.: *Trichomonas vaginalis* Exosomes Deliver Cargo to Host Cells and Mediate Host:Parasite Interactions. *PLoS Pathog.* 9, 22-24 (2013).
30. Tong, T. T., Mörgelin, M., Forsgren, A. & Riesbeck, K.: *Haemophilus influenzae* Survival during Complement-Mediated Attacks Is Promoted by *Moraxella catarrhalis* Outer Membrane Vesicles. *J. Infect. Dis.* 195, 1661-1670 (2007).
31. Cheruvanky, A. et al. Rapid isolation of urinary exosomal biomarkers using a nanomembrane ultrafiltration concentrator. *Am. J. Physiol. Renal. Physiol.* 292, F1657-F1661, (2007).
32. Achilli, E. et al.: Preparation of protein nanoparticle by dynamic aggregation and ionizing-induced crosslinking. *Colloids Surfaces A Physicochem. Eng. Asp.* 486, 161-171 (2015).

Germany

Sartorius Lab Instruments GmbH & Co. KG
Otto-Brenner-Strasse 20
37079 Goettingen
Phone +49 551 308 0

USA

Sartorius Corporation
565 Johnson Avenue
Bohemia, NY 11716
Phone +1 631 254 4249
Toll-free +1 800 635 2906

 For further information, visit
www.sartorius.com